

# THE DISPLAY COLLECTION



# t h e d i s p l a y c o

The Display Collection is a comprehensive range of display and lighting components designed to a very high specification.

*Be creative.* You will be amazed what you can achieve with this product range with a little bit of imagination.

*Not sure how to create the display?* Then give us a call - we will take you through the design, step by step, to ensure you have all the components you require.

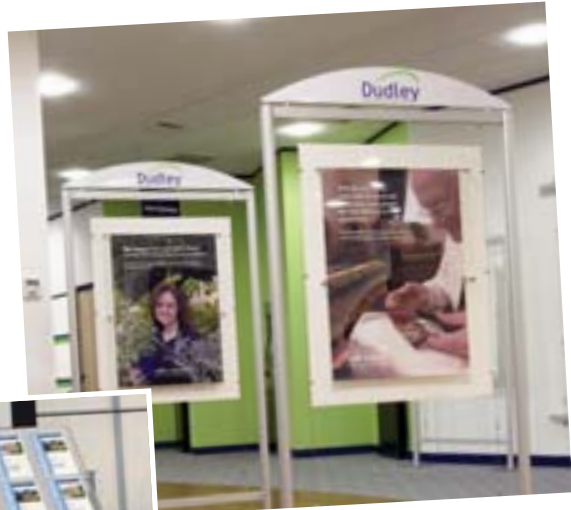

**New**  
Freestanding Displays  
- ask for details



# l l e c t i o n      C O N T E N T S



<b>Kits</b>	<b>8</b>
The easiest ways to create a perfect display	8-11
<b>Sign systems</b>	<b>12</b>
Wall mounted supports for signs & graphics	13-15
<b>Cable systems</b>	<b>16</b>
1.5mm cable & supports	17-23
3mm cable & supports	24-25
<b>Installation accessories &amp; tools</b>	<b>26</b>
Installation accessories for cables & rods	26
Channel installation ideas	27
Tools and spares	28
<b>Rod systems</b>	<b>29</b>
3mm rod system & supports	30-32
6mm rod system & supports	33-36
10mm rod system & supports	37-39
<b>Graphic displays</b>	<b>40</b>
Acrylic pockets & poster holders	41-42
Hook-on accessories	43
Leaflet dispensers	44
Acrylic accessories	45
Framed posters and 'A' boards	46
Banner & hanging rails	47
<b>Product displays</b>	<b>48</b>
Shelving	49
Acrylic display cubes	50
<b>Lighting</b>	<b>51</b>
How to choose your lighting	52
Cantilevered lights	53-54
Straight lights	55
Wirelights	56
Hightrack kits	57
Highlight	58
Lighting accessories	59
<b>Freestanding displays</b>	<b>60</b>
Freestyle - single units	61
Flexiframe - multiple units & frame accessories	62
Info-post	63
<b>Light boxes</b>	<b>64</b>
Cold cathode and curved light boxes	65
XtraLite	66
<b>Moving displays</b>	<b>67</b>
E-motion	68
<b>Digital displays</b>	<b>69</b>
Digital display screens & kits	70-72
<b>Sales support material</b>	<b>73</b>
Samples & promotional material	73
Component measurements	74

# create the perfect display for

Wall mounted...



Signage suspended from the ceiling...



Floor-to-ceiling creativity...

Versatile cable and rod systems that allow you to create exactly the display you want.



# you...

**Freestanding displays**



**Add low voltage lighting**



**Add movement...**

and watch your sales increase



**Floating multi-media presentations...**



The very latest digital displays will add sound and movement to your displays...and increase sales too...

**Add flexibility to your displays...**



Incredibly slim, bright light boxes create maximum impact...



Ultra-bright, slim light boxes can be suspended or wall mounted... used on their own or combined with other displays...



## 4 easy steps to create your perfect display:

1. Decide if you want your display fitted ceiling to floor, wall mounted or freestanding.
2. Decide if you want to display posters, leaflets, shelving or a combination.
3. Select size of display - from A4 to A1
4. Increase the impact of your display - add lighting. See page 51 for lighting available.

## Poster holders

### Ceiling to floor kits

- using 1.5mm cable
- display posters from A1 to A4



KA1  
A1 portrait

KA2L  
A2 landscape

Examples:



K2A3L  
2 x A3 landscape



K3A4  
3 x A4 portrait



K7P  
3 x double A4 pockets



K8P  
3 x treble A4 pockets



K7PH  
A3 landscape header plus  
6 x A4 portrait pockets

Item Code:	Pocket Size	No. of Pockets	Format:
KA1	A1	1	Portrait
KA2	A2	1	Portrait
K2A3	A3	2	Portrait
K3A4	A4	3	Portrait
KA1L	A1	1	Landscape
KA2L	A2	1	Landscape
K2A3L	A3	2	Landscape
K3A4L	A4	3	Landscape

Kits with double poster pockets:			
K7P	A4	3x2	Portrait
K7PH	A3	1	Landscape header
	A4	6	Portrait

Kits with treble poster pockets			
K8P	A4	3x3	Portrait

### Wall mounted kits

- using 1.5mm cable
- display posters from A1 to A4

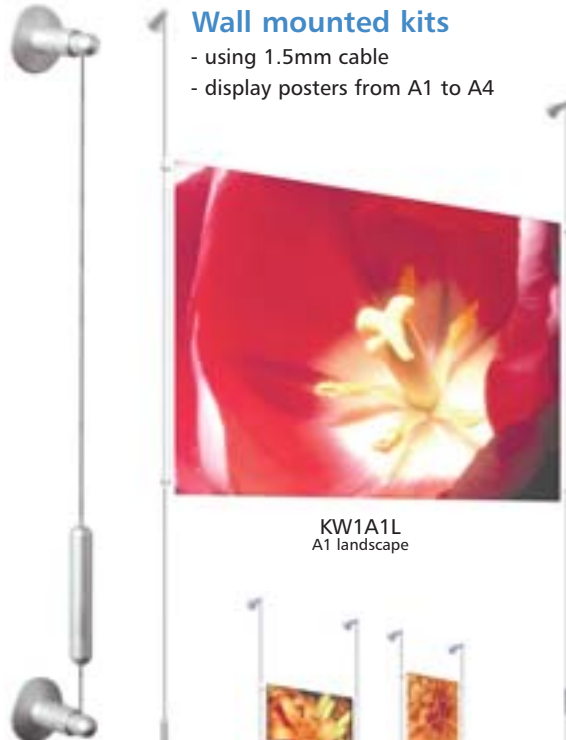

KW1A1L  
A1 landscape

KW1A2  
A2 portrait

KW3A4L  
3 x A3 landscape

KW3A4  
3 x A4 portrait

K7PW  
6 x A4 portrait

K7PHW  
1 x A3 Landscape  
6 x A4 portrait

K8PW  
9 x A4 portrait

Item Code:	Pocket Size	No. of Pockets	Format:
KW1A1	A1	1	Portrait
KW1A2	A2	1	Portrait
KW2A3	A3	2	Portrait
KW3A4	A4	3	Portrait
KW1A1L	A1	1	Landscape
KW1A2L	A2	1	Landscape
KW2A3L	A3	2	Landscape
KW3A4L	A4	3	Landscape

Kits with double poster pockets:			
K7PW	A4	6	Portrait
K7PHW	A3	1	Landscape
	A4	6	Portrait

Kits with treble poster pockets			
K8PW	A4	9	Portrait

### Hook on kits

- using 1.5mm floor to ceiling cable
- to display A4 posters
- acrylic pockets hook onto rods supported on floor/ceiling cables

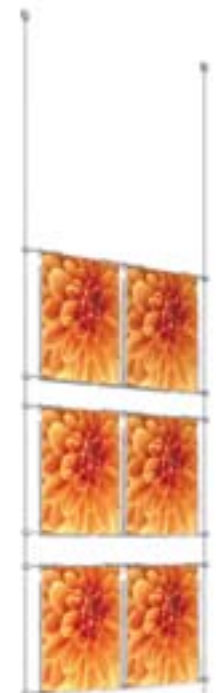

KEH2/3  
6 x A4 portrait

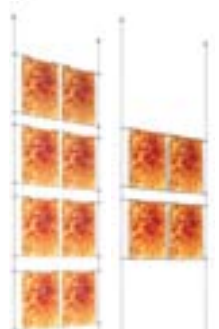

KEH2/4  
8 x A4 portrait

KEH2/2  
4 x A4 portrait

Item Code:	No. of Pockets
A4 portrait pockets:	

KEH2/2	2x2
KEH2/3	2x3
KEH2/4	2x4

Picture code to paper sizes:

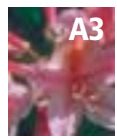

Landscape:

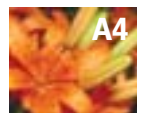

### Wall mounted kits

- acrylic pocket with wall mounts
- a highly attractive way to present graphics and posters
- A4 and A5 pockets are 2mm thick acrylic, all other sizes are 3mm thick.
- pockets supplied with satin chrome wall supports that hold the pocket 25mm away from the wall



KMA1PW-WM  
A1 portrait



KMA1LW-WM  
A1 landscape



KMA3LW-WM  
A3 landscape

Item Code:	Pocket Size:	Format:
KMA0PW-WM	A0	Portrait
KMA1PW-WM	A1	Portrait
KMA2PW-WM	A2	Portrait
KMA3PW-WM	A3	Portrait
KMA4PW-WM	A4	Portrait
KMA5PW-WM	A5	Portrait
KMA1LW-WM	A1	Landscape
KMA2LW-WM	A2	Landscape
KMA3LW-WM	A3	Landscape
KMA4LW-WM	A4	Landscape
KMA5LW-WM	A5	Landscape

### Suction pad kits

- a highly economical solution to create powerful window and internal displays that are held in position with suction pads.
- No installation required - just assemble and fix to window.
- select from A4 or A3 pockets, portrait or landscape.
- each kit is supplied with 2 rods, 4 clear suction pads, acrylic pockets, supports and full assembly instructions.
- kits available with 3 or 4 pockets



KS3A4  
3 x A4 portrait

Item Code:	Pocket Size	No. of Pockets	Format:
KS1A2-3	A2	1	Portrait
KS2A3-3	A3	2	Portrait
KS3A4-3	A4	3	Portrait
KS3A3-3	A3	3	Portrait
KS4A4-3	A4	4	Portrait
KS1A2L-3	A2	1	Landscape
KS2A3L-3	A3	2	Landscape
KS3A4L-3	A4	3	Landscape
KS3A3L-3	A3	3	Landscape
KS4A4L-3	A4	4	Landscape

### 3mm rod kits

- for displays that are suspended from the top.
- a floating option that allows information to be changed easily
- can be fitted to ceiling or wall
- ideal for really awkward windows
- supplied with 2m rods



Unique fitting allows the unit to be pulled away from the wall or window easily.



The bottom of the 3mm rod is supplied with a stylish black PVC end cap.

Easy access pockets - change the display within seconds.

Item Code:	Pocket Size	No. of Pockets	Format:
K4A4-3	A4	4	Portrait
K3A4-3	A4	3	Portrait

### Poster holders + leaflet dispensers

- choose from floor to ceiling or wall mounted
- A1 portrait or A2 landscape poster holder
- kit comes with poster holder, 2 x A4 leaflet dispensers, 5 x 1/3 A4 leaflet dispensers.



Item Code: Items:

Item Code:	Items:
Floor to ceiling: K9D	1 x A1 poster pocket 2 x A4 dispensers 5 x 1/3 A4 dispenser 4m cable
K10D	1 x A2 poster pocket 2 x A4 dispensers 4 x 1/3 A4 dispenser 4m cable
Wall mounted: K9DW	1 x A1 poster pocket 2 x A4 dispensers 5 x 1/3 A4 dispenser 3m cable
K10DW	1 x A2 poster pocket 2 x A4 dispensers 4 x 1/3 A4 dispenser 3m cable

# Kits

## Leaflet dispensers

### Ceiling to floor kits



Item Code:	Pocket Size	No. of Pockets	Format:
K1D	A4	3	Portrait
K2D	A4	3 x double A4 pockets	Portrait
K3D	A5	3 x treble A5 pockets	Portrait
K5D	1/3 A4	3 x quadruple 1/3 A4 pockets	Portrait

### Wall mounted kits

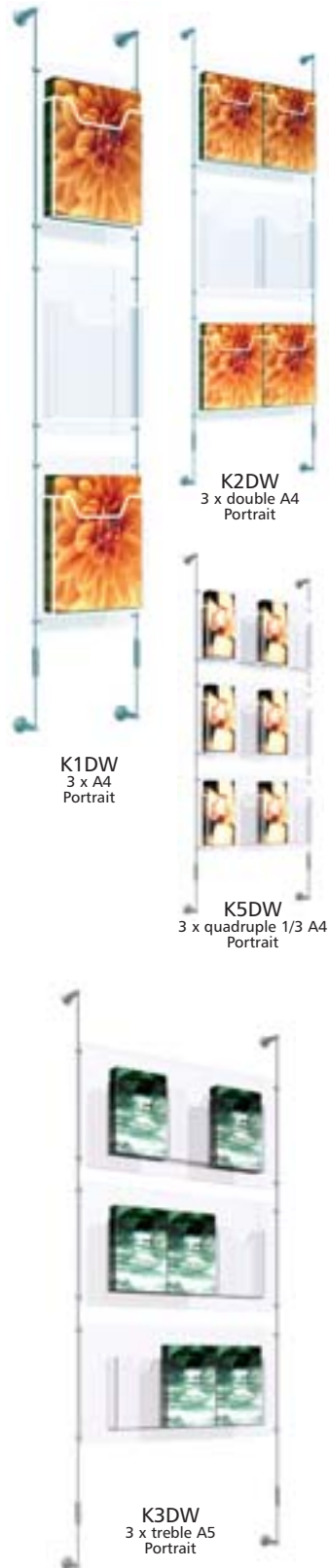

Item Code:	Pocket Size	No. of Pockets	Format:
K1DW	A4	3	Portrait
K2DW	A4	3 x double A4 pockets	Portrait
K3DW	A5	3 x treble A5 pockets	Portrait
K5DW	1/3 A4	3 x quadruple 1/3 A4 pockets	Portrait

## Freestanding units

### 10mm rod kits

- units consist of 10mm stainless steel rods which are screwed into a steel base.
- Panel clamps support acrylic pockets or leaflet dispensers
- supplied flat packed for easy assembly
- 2000mm or 1500mm high

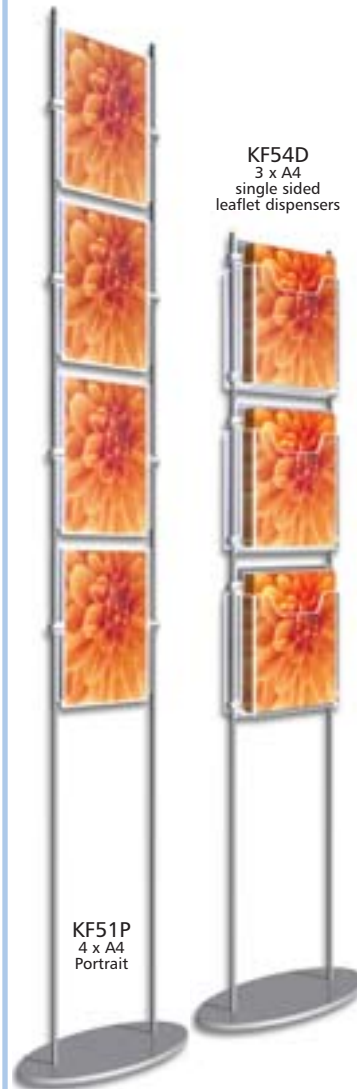

Item Code:	Size:
2000mm high units:	
KF51P	4 x A4 portrait pockets
KF53P	3 x A3 portrait pockets
KF56DP	3 x A4 dispensers plus 1 x A4 portrait pocket

Item Code:	Size:
1500mm high poster holder units:	
KF50P	3 x A4 portrait pockets
KF52L	3 x A4 landscape pockets
KF53L	4 x A4 landscape pockets
1500mm high leaflet dispenser units:	
KF54D	3 x A4 single sided
KF54DD	3 x A4 double sided
KF55DP	2 x A4 single sided plus 1 x A4 portrait pocket

### Large freestanding kits

- larger units with many display options using poster holders, leaflet dispensers and flat or sloping shelves
- 3 frame widths to choose from, all units 1980mm high, base 330mm diameter
- supplied flat pack with easy to follow assembly instructions
- quickFit cable supplied cut to length



Item Code:	Size:
850mm wide frame with poster holders:	
KFR-759-A1	1 x A1 poster
KFR-759-2A2	2 x A2 posters
KFR-759-3A3	3 x A3 posters
KF12P	3 x double A4 (6 A4 pockets)
KF15P	4 x double A4 (8 A4 pockets)
KF18P	3 x triple A4 (9 A4 pockets)
KF19P	4 x triple A4 (16 A4 pockets)

## Shelving

### Ceiling to floor kits



KS2A1 Large

- 2 x 6mm toughened safety glass shelves can be easily removed for cleaning.
- supplied with 4m cable
- add extra shelf or poster holder

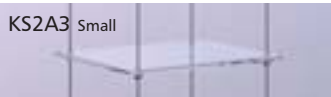
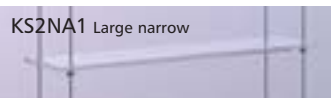

Item Code:	Shelf size: w x d	Cable centres: w x d
------------	-------------------	----------------------

**Large:**  
KS2A1 688 x 330 628 x 300

Extra additions:  
K688330 Add extra shelf  
KMA2LW A2 landscape poster holder  
KMA1PW A1 portrait poster holder

**Medium:**  
KS2A2 514 x 330 454 x 300

Extra additions:  
K514330 Add extra shelf  
KMA3LW A3 landscape poster holder  
KMA2PW A2 portrait poster holder

**Small:**  
KS2A3 391 x 330 331 x 300

Extra additions:  
K391330 Add extra shelf  
KMA4LW A4 landscape poster holder  
KMA3PW A3 portrait poster holder

**Large Narrow:**  
KS2NA1 688 x 180 628 x 150

Extra additions:  
K688180 Add extra shelf  
KMA2LW A2 landscape poster holder  
KMA1PW A1 portrait poster holder

### Wall mounted kits



KWS2A1 Large

- 2 x 6mm toughened safety glass shelves can be easily removed for cleaning.
- supplied with 3m cable
- add extra shelf or poster holder

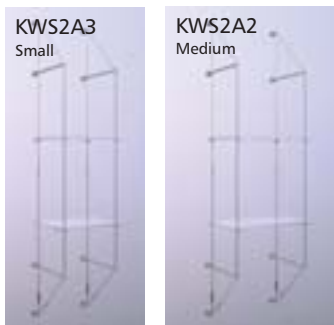

KWS2A3 Small

KWS2A2 Medium

Item Code:	Shelf size: w x d	Cable centres: w x d
------------	-------------------	----------------------

**Large:**  
KWS2A1 688 x 330 628 x 300

Extra additions:  
K688330 Add extra shelf  
KMA2LW A2 landscape poster holder  
KMA1PW A1 portrait poster holder

**Medium:**  
KWS2A2 514 x 330 454 x 300

Extra additions:  
K514330 Add extra shelf  
KMA3LW A3 landscape poster holder  
KMA2PW A2 portrait poster holder

**Small:**  
KWS2A3 391 x 330 331 x 300

Extra additions:  
K391330 Add extra shelf  
KMA4LW A4 landscape poster holder  
KMA3PW A3 portrait poster holder

**Large Narrow:**  
KWS2NA1 688 x 180 628 x 150

Extra additions:  
K688180 Add extra shelf  
KMA2LW A2 landscape poster holder  
KMA1PW A1 portrait poster holder

## Hanging banner rails

- ideal for suspending clothing and large banners
- cables fit floor to ceiling
- supplied with 25mm hanging rails, 914mm long, height fully adjustable and 4m cables



KB1 Single banner rail

KB2 Double banner rail



KBS1 Banner rail plus glass shelf



KB1P Banner rail plus A2 poster pocket

Item Code:	No. of Rails
------------	--------------

KB1	1
KB2	2
KBS1	1 rail + 1 glass shelf 618 x 330mm
KB1P	1 rail + 1 x A2 landscape poster pocket



K20FS 6 large flat shelves

K12FS 6 A4 sloping shelves

K18FS A1 poster plus 2 flat shelves

KAF2-30D 6 triple 1/3 A4 leaflet dispensers plus 2 double A4 pockets

Item Code:	Size:
------------	-------

850mm wide frame with shelves:  
K21FS 3 large flat shelves 688 x 330mm  
K12FS 6 A4 sloping shelves  
K14FS 6 A3 sloping shelves

1590mm wide frame with shelves:  
K20FS 6 large flat shelves 688 x 330mm

Item Code:	Size:
------------	-------

850mm wide frame with shelves AND poster:  
K18FS A1 poster holder plus 2 large flat glass shelves 688 x 330mm

1590mm wide frame with shelves AND poster:  
K22FS Double width 2 x A1 poster holder plus 4 large flat glass shelves 688 x 330mm

Item Code:	Size:
------------	-------

2 x 850mm wide, hinged frames with leaflet dispensers:  
Single sided:  
KAF2-30D 6 x triple 1/3 A4 (30 1/3 A4 pockets) plus 2 x double A4 (4 A4 pockets)

Double sided:  
KAF2-30DD 6 x triple 1/3 A4 (60 1/3 A4 pockets) plus 4 x double A4 (8 A4 pockets)

# Sign systems

All you need to create high impact signs



- Wall mounted supports
- Suspended signs
- Directional signs
- Banner displays
- Hook-on presentations
- Projecting signs
- Acrylic panels and poster holders
- Show off your signs with elegant illumination
- Instant solutions for exhibition signage



# Wall-mounted sign supports

- hold signs away from the wall
- enhance appearance
- easy to keep clean

## Supports for panels/signs with holes

### 12mm diameter supports\*



**WM12**  
20mm length

Item Code:	Finish:	Panel hole size:	Panel thickness:	Requires screw size:
<b>WM12</b>	<b>Satin Chrome</b>	9mm	up to 12mm	No. 6

### 16mm diameter supports\*



**WM19 - Flush Cap**

Designed to be used with a screw to mount a panel flat on the wall

<b>WM19</b>	<b>Satin Chrome</b>	6mm	-	No. 10
-------------	---------------------	-----	---	--------



**WM05**  
14mm length

<b>WM05</b>	<b>Satin Chrome</b>	6mm	up to 6mm	No. 10
-------------	---------------------	-----	-----------	--------



**WM05-13**  
25mm length

<b>WM05-13</b>	<b>Satin Chrome</b>	6mm	up to 13mm	No. 10
----------------	---------------------	-----	------------	--------



**WM05L-20**  
40mm length

<b>WM05L-20</b>	<b>Satin Chrome</b>	6mm	up to 20mm	No. 10
-----------------	---------------------	-----	------------	--------



**WM18**  
25mm length  
Supplied with a 19mm cap

<b>WM18</b>	<b>Satin Chrome</b>	6mm	up to 13mm	No. 10
-------------	---------------------	-----	------------	--------



**WM08**  
32mm overall length  
Rubber shaft for use with glass.  
Can hold 2 x 6mm thick panels only. Barrel is 14mm long.

<b>WM08</b>	<b>Satin Chrome</b>	9mm	12mm	No. 10
-------------	---------------------	-----	------	--------

### 25mm diameter supports\*



**WM15**  
25mm length

Item Code:	Finish:	Panel hole size:	Panel thickness:	Requires screw size:
<b>WM15</b>	<b>Satin Chrome</b>	12mm	6-20mm	No. 10



**WM16**  
50mm length

<b>WM16</b>	<b>Satin Chrome</b>	12mm	6-20mm	No. 10
-------------	---------------------	------	--------	--------



**WM17** 75mm length

<b>WM17</b>	<b>Satin Chrome</b>	12mm	6-20mm	No. 10
-------------	---------------------	------	--------	--------

\* Components shown actual size

Standard finish satin chrome, all other finishes on request

Full dimensions - p74

All components shown on this page are in Satin Chrome finish. Most components are also available in the following finishes:

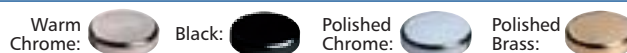

# Wall-mounted supports

## Accessories for panels/signs with holes

### Support joiner/panel spacer



- make a strong design statement with one panel in front of another to create a double-depth sign
- takes a panel up to **6mm** thick
- also use to join two supports together to achieve required length
- invisible when in use

Item Code: Finish:

**PC31 Brass**

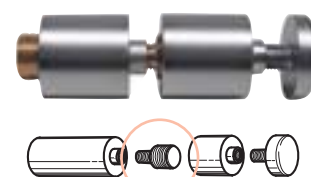

PC31

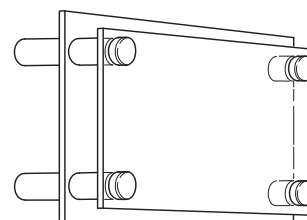

## Supports for panels without holes

### Panel support



- for signs, panels or acrylic pockets up to **7mm** thick
- locks to any angle
- ideal to use with easy access pockets (page 41)

Item Code: Finish:

**WM09 Satin Chrome**



### Plastic spacer



- enables a sign, panel or acrylic pocket to be fitted without a hole. Designed for use with **16mm** diameter fittings
- available in 2 sizes: **2mm** & **3mm** thick
- saves time and money, as there is no need to drill panels
- clean appearance as no visible screw

Item Code: Size:

**WMS-2 2mm**  
**WMS-3 3mm**



WMS

### Four way spacer



- allows multiple panels to be butted closely together.
- holds panel on corner
- takes panels up to **6mm** thick

Item Code: Finish:

**WM20 Satin Chrome**



For components to create stunning directory signs, please see the cable and rod sections.

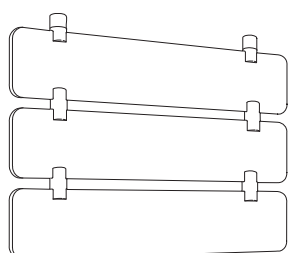

# Wall-mounted supports

## Clamps for signs/shelves

### Project 19mm from wall

- supports that can be used vertically for signs or horizontally to support shelves
- available in 2 sizes to hold signs/shelves up to **10mm** thick



WM01

WM02

For signs/shelves up to **7mm** thick

Item Code: Finish:

**WM01 Satin Chrome**

For signs/shelves up to **10mm** thick

Item Code: Finish:

**WM02 Satin Chrome**

### Project 5mm from wall

- supports that can be used vertically for signs or horizontally to support shelves
- available in 2 sizes to hold signs/shelves up to **10mm** thick



WM03

WM04

For signs/shelves up to **7mm** thick

Item Code: Finish:

**WM03 Satin Chrome**

For signs/shelves up to **10mm** thick

Item Code: Finish:

**WM04 Satin Chrome**

## Hooks

### Hook



- for panels up to **3mm** thick with holes

Item Code: Finish:

**WM06 Satin Chrome**

### Picture hook



Item Code: Finish:

**WM07 Satin Chrome**

## Support for wooden sign or shelf



Use vertically to support signs

Use horizontally to support shelves

- support that can be used vertically for signs or horizontally to support shelves
- can be locked to any angle
- for glass shelves add P08 retaining screw

Item Code: Finish:

**WM10 Satin Chrome**

### Retaining screw



- to hold glass shelf or sign fitted with WM10

- holds 6mm thick as standard
- plastic insert to protect glass
- **hole 6mm dia**, 12mm from edge

Item Code: Finish:

**P08 Satin Chrome**

## Decorative wall plate



- decorative plate that can be positioned under any standard wall mount or sign support
- creates an up-market appearance and provides added strength to the installation
- **38mm** diameter

Item Code: Finish:

**P01 Satin Chrome**

## Fixing panel to wall



- screw fix panel to wall
- **12.5mm** spacer

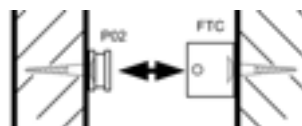

Item Code: Finish:

**KPP-1 Satin Chrome**



# Cable systems



\* Projects designed and installed by Atlas Display (DHB) Ltd



creative

flexible

highest quality

easy to install

- Choose from 1.5mm or 3mm thick galvanised steel cables - will not fray, kink or mark, unlike stainless steel
- 1.5mm cable supports up to 120kg, 3mm cable up to 200kg
- Designed and manufactured to the highest possible standards of quality
- Life time guarantee on all metal components
- Extensive range of components and accessories ensures complete design flexibility
- Low-voltage lighting can be fully integrated onto the cable systems
- Stylish yet discreet design
- Easy to install, with an installation service available if required
- Available in standard finish - satin chrome. Polished chrome, brass and special finishes are available on request



# 1.5mm cable - fitting options

## Ceiling to floor

- the basic kit for fixing between ceiling and floor
- includes top and bottom fittings, 4m of cable and spring tensioner
- also available with insulated cable for use with lighting on exhibition stands



Item code: Finish:  
**CA4 Satin Chrome**

With insulated cable:  
**CA4S Satin Chrome**

## Ceiling to wall

- ideal for supporting signs and graphics
- includes top and bottom fittings, spring tensioner and 3m cable



Item code: Finish:  
**CCW Satin Chrome**

## Wall to wall

- use for suspending signs and graphics
- includes top and bottom fittings, spring tensioner and 3m cable



Item code: Finish:  
**CWW Satin Chrome**

## Wall to floor

- use for suspending signs and graphics
- includes top and bottom fittings, spring tensioner and 3m cable



Item code: Finish:  
**CWF Satin Chrome**

## Angled top and bottom

- use on sloping or flat surfaces
- includes top and bottom fittings, spring tensioner and 4m cable



Item code: Finish:  
Angled top to angled bottom:  
**CAA Satin Chrome**

Angled top to regular bottom fitting:  
**CAF Satin Chrome**



**K3A4L K3A4**

Item code: Item:  
**K3A4L Kit**  
**K3A4 Kit**





**KW2A3 KW2A3L**

Item code: Item:  
**KW2A3 Kit**  
**KW2A3L Kit**

Standard finish satin chrome, all other finishes on request

All cables can be supplied in longer lengths.

Polished Chrome:  Polished Brass: 

# 1.5mm cable - fitting options

## Ceiling suspended fittings

### Ceiling fitting supplied with 2m long cable

- ideal for supporting signs



Item Code: Finish:

**C2 Satin Chrome**

### Top cable fitting and panel clamp

- 2m long cable with top fitting and panel clamp to take up to 7mm or 10mm thick panel  
- ideal for supporting signs



For panels up to 7mm thick

Item Code: Finish:

**KC2-CG05 Satin Chrome**

For panels up to 10mm thick

Item Code: Finish:

**KC2-CG05-10 Satin Chrome**



### Ceiling fitting with cable and weight

- top fitting with 4m long cable and bottom weight measuring 100mm h x 30mm dia. Weight 0.55kg  
- weight ensures taut cable for signs and banners

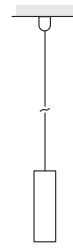

Item Code: Finish:

**CCT Satin Chrome**

### Angled ceiling fitting with cable and weight

- wall mounted support with adjustable angle. Weight 0.55kg  
- weight ensures taut cable for signs and banners

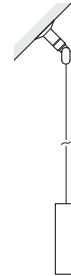

Item Code: Finish:

**CAT Satin Chrome**

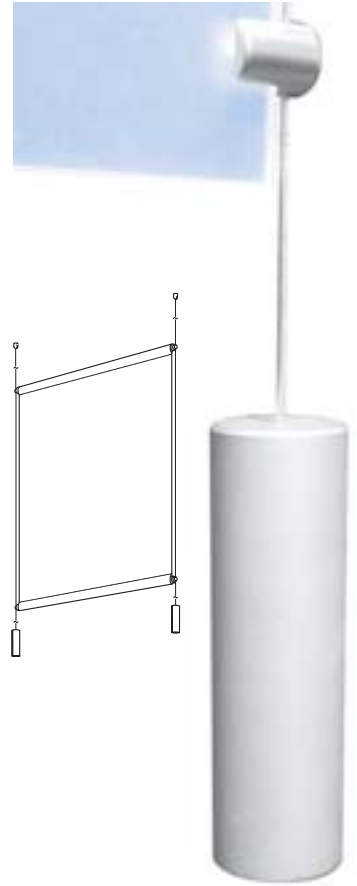

## Quick fit cable

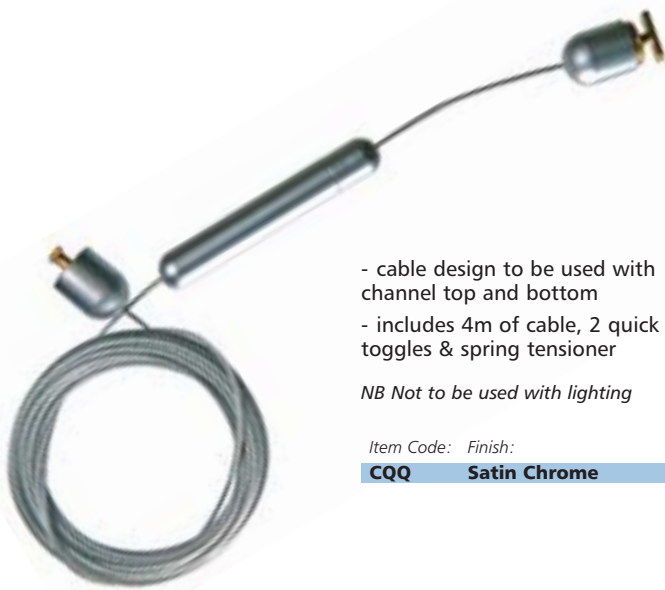

- cable design to be used with channel top and bottom  
- includes 4m of cable, 2 quick fit toggles & spring tensioner

NB Not to be used with lighting

Item Code: Finish:

**CQQ Satin Chrome**

## Extra strong ceiling/wall fitting



- can be used with any standard ceiling fitting or wall mount

Item Code: Finish:

**HDS Satin Chrome**

## Decorative cover disc - thread through

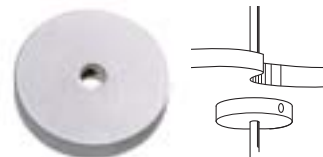

- can be used with any standard cable or 3mm rod  
- use below false ceiling to hide hole, giving a professional finish

Item Code: Finish:

**CD-4 Satin Chrome**

## Decorative support plate



- can be used with any standard ceiling fitting or wall mount

Item Code: Finish:

**P01-PC01 Satin Chrome**

Full dimensions - p74

Standard finish satin chrome, all other finishes on request

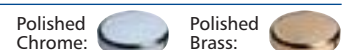

# 1.5mm cable - fitting options

## Double cable fittings

- available in **150mm** and **300mm** cable centres
- creates a stylish support for shelving and graphics

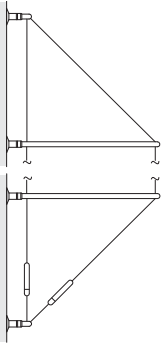

### Wall to wall fittings with two 3m cables

#### 150mm cable centres

Item Code: **C2WW-15** Finish: **Satin chrome**

#### 300mm cable centres

Item Code: **C2WW-30** Finish: **Satin chrome**



KWS2A1 - see website for full range of shelving kits

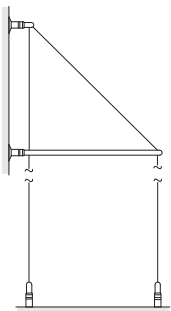

### Wall to floor fittings with two 3m cables

#### 150mm cable centres

Item Code: **C2WF-15** Finish: **Satin chrome**

#### 300mm cable centres

Item Code: **C2WF-30** Finish: **Satin chrome**

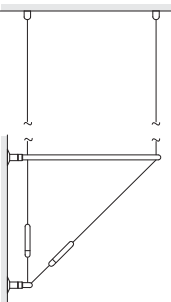

### Ceiling to wall fittings with two 3m cables

#### 150mm cable centres

Item Code: **C2CW-15** Finish: **Satin chrome**

#### 300mm cable centres

Item Code: **C2CW-30** Finish: **Satin chrome**

## Twin cable fittings

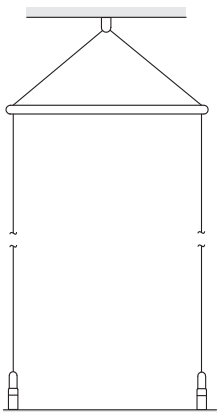

### Twin cable with single ceiling fitting

- single ceiling fitting, with two **4m** long cables fixed to the floor
- spacer bar to ensure cable centres **300mm**
- other sizes available on request
- tensioners fitted at bottom



Item Code: **C2A4F** Finish: **Satin Chrome**

Standard finish satin chrome, all other finishes on request



Full dimensions - p74

All cables can be supplied in longer lengths.

Polished Chrome:  Polished Brass: 

# Panel clamps - 1.5mm cable

## Vertical clamps

For panels up to 4mm thick:



Item Code: Finish:

**Single**  
CG03 Satin Chrome

**Double**  
CG04 Satin Chrome

For panels up to 7mm thick:



Item Code: Finish:

**Single**  
CG01 Satin Chrome

**Double**  
CG02 Satin Chrome

For panels up to 12.7mm thick:



Item Code: Finish:

CG14 Satin Chrome

For panels up to 12.7mm thick with holes:



- with insert for holes. Supports two 6mm thick glass panels with poster between.

Item Code: Finish:

CG08 Satin Chrome

## Multi-position clamps - can be locked at any angle

For panels up to 7mm thick:

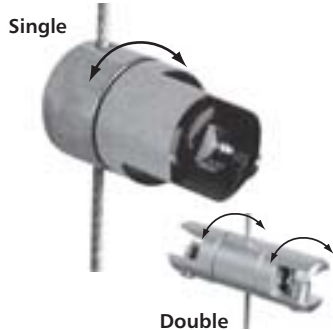

Item Code: Finish:

**Single**  
CG11 Satin Chrome

**Double**  
CG21 Satin Chrome

For panels up to 10mm thick:

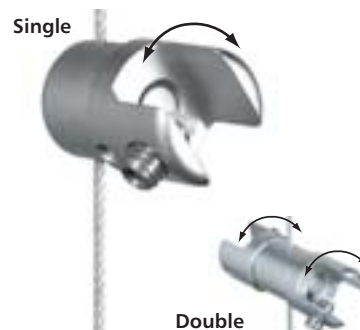

Item Code: Finish:

**Single**  
CG13 Satin Chrome

**Double**  
CG23 Satin Chrome

## Clamps for wide panels - top/bottom clamps for panels wider than the distance between cables

For panels up to 7mm thick:



Item Code: Finish:

CG09 Satin Chrome

Multi-position clamps for panels up to 7mm thick:

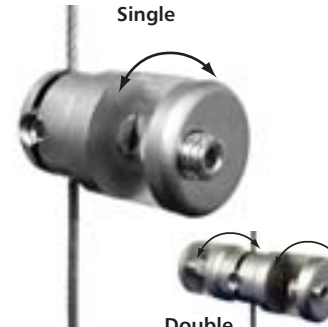

- can be locked into any position

Item Code: Finish:

**Single**  
CG12 Satin Chrome

**Double**  
CG22 Satin Chrome

For acrylic accessories see pages 40-45

Full dimensions - p74

Standard finish satin chrome, all other finishes on request

Polished Chrome:  Polished Brass: 

# Panel supports - 1.5mm cable

## Supports for panels with holes

### For panels 5-6mm thick



- hole size **6mm** diameter
- supports for panels up to **20mm** thick available on request

Item Code: Finish:

**Single**  
**CS13** Satin Chrome

**Double**  
**CS23** Satin Chrome



**CS13 & CS23**  
for extra thick panels up to 20mm, specify size required.  
Add £1.00 to price shown.  
Ref example: CS13/S

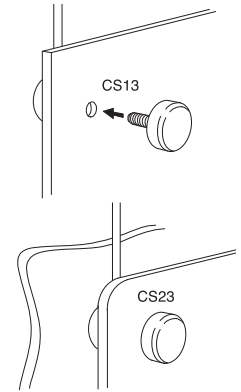

## Supports for screw fix panels



### Support

- support for any item fitted with boss fitting - see P02

Item Code: Finish:

**Single**  
**CS03** Satin Chrome

**Double**  
**CS04** Satin Chrome



### P02 Boss

- Boss for use with supports CS03/CS04
- use with up to No. 10 countersunk wood screw or bolt

Item Code: Finish:

**P02** Nickel

### P02-2 Boss

- as above, but double sided, to attach two components together

Item Code: Finish:

**P02-2** Nickel

## Hooks

### Hook for panels up to 3mm thick with holes

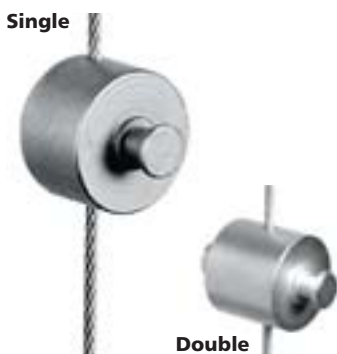

Item Code: Finish:

**Single**  
**CH01** Satin Chrome

**Double**  
**CH02** Satin Chrome

### Picture hooks



Item Code: Finish:

**Single**  
**CS12** Satin Chrome

**Double - not shown**  
**CS22** Satin Chrome

## Nylon tip screws



All panel and shelving clamps are supplied with nylon tip as standard\*

- nylon tip protects glass and acrylic

\* except CG03, CG04

For spare screws see page 28

Full dimensions - p74

Standard finish satin chrome, all other finishes on request

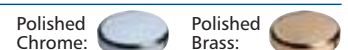

# Shelf supports - 1.5mm cable

## Under-shelf support



- locates under shelf
- inconspicuous
- for drilled and slotted shelf
- shelf hole size **10mm**, slot width **2mm**

Item Code: Finish:  
**CS01 Satin Chrome**



## Supports for wooden or glass shelves

### Shelf support



- adjustable to any angle of slope
- can be locked into position
- for glass shelves add ref. P08 (see right)

Item Code: Finish:  
**Single CS11 Satin Chrome**

**Double CS21 Satin Chrome**

### Screw to retain glass shelves



- Used with CS11 or CS21 to hold **6mm** thick as standard
- flush finish
  - plastic insert to protect glass
  - hole **6mm** dia, **6mm** thick glass
  - hole **12mm** from the edge of glass

Item Code: Finish:  
**P08 Satin Chrome**

## Clamps for glass shelves

### Clamp for glass shelves up to 7mm thick



- for glass shelves without holes

Item Code: Finish:  
**Single CG06 Satin Chrome**

**Double CG07 Satin Chrome**

### Clamp for glass shelves up to 12.7mm thick



- for glass shelves without holes

Item Code: Finish:  
**CG15 Satin Chrome**

## Multi-position clamps for glass shelves

### Multi-position clamp for glass shelves up to 7mm thick

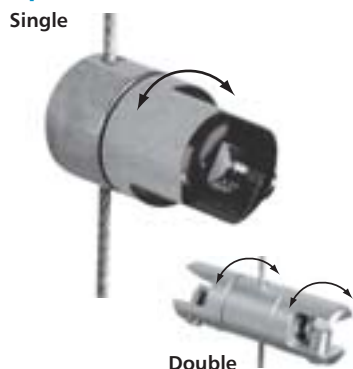

- adjustable to any angle
- can be locked into position

Item Code: Finish:  
**Single CG11 Satin Chrome**

**Double CG21 Satin Chrome**

### Multi-position clamp for glass shelves up to 10mm thick

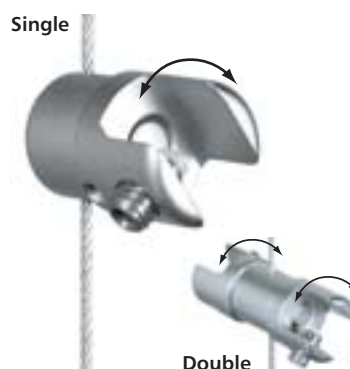

- adjustable to any angle
- can be locked into position

Item Code: Finish:  
**Single CG13 Satin Chrome**

**Double CG23 Satin Chrome**

Full dimensions - p74

Standard finish satin chrome, all other finishes on request

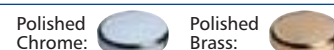

# Shelf & rod supports - 1.5mm cable

## Supports to hold rods

### Rod support

Single



Double



- for 6mm diameter rods
- rods will hold acrylic pockets, leaflet holders, banners & graphics

Item Code: Finish:

**Single**  
**CS05 Satin Chrome**

**Double**  
**CS06 Satin Chrome**

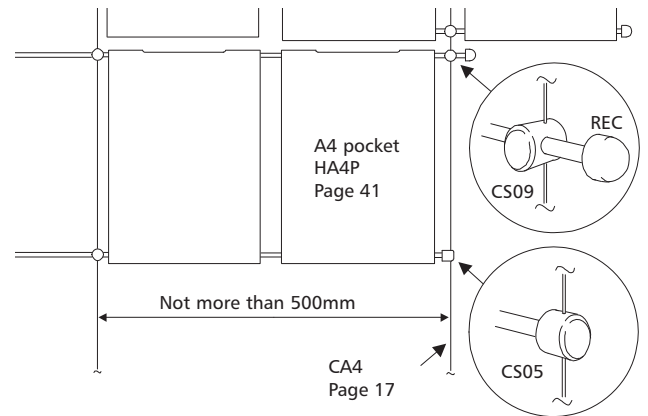

### Rod support - fixed position

- to hold 6mm rod



Item Code: Finish:

**CS09 Satin Chrome**

### Rod support - Multi-position



- to hold 6mm rod
- can be locked in any position

Item Code: Finish:

**CS07 Satin Chrome**

See page 43 for Acrylic Hook-on Accessories

### Unthreaded rod - 6mm dia



Item Code: Finish:

**0.5m rod**  
**R500P Satin Chrome**

**R1000P Satin Chrome**

### Rod end caps



Item Code: Finish:



**End cap for 6mm rod**  
**REC Satin Chrome**

**Black PVC end cap for 6mm rod**  
**REC-P/BL Black**



Full dimensions - p74

Standard finish satin chrome, all other finishes on request

Polished Chrome:  Polished Brass: 

# Cable & panel clamps - 3mm cable

## 3mm cable

4m cable with ceiling to floor fixings



3mm cable supports up to 200kg, giving all the advantages of a robust appearance with the smallest size supports on the market. Fittings have the same cable centres as 1.5mm cable. See page 26 for installation accessories.

- includes spring loaded tensioner
- the basic kit for fixing between ceiling and floor
- all cables can be supplied in longer lengths

Item Code: Finish:

**CA4-3 Satin Chrome**

Add 75p for each extra metre of cable

## Decorative cover disc - thread through

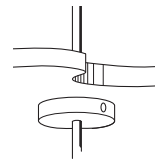

- can be used with any standard cable or 3mm rod
- use below false ceiling to hide hole, giving a professional finish

Item Code: Finish:

**CD-4 Satin Chrome**

## Decorative support plate

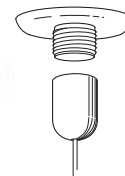

- can be used with any standard ceiling fitting or wall mount

Item Code: Finish:

**P01-PC01 Satin Chrome**

## Vertical clamps

For panels up to 7mm thick



Item Code: Finish:

**CG01-3 Satin Chrome**

For panels up to 12.7mm thick



Item Code: Finish:

**CG14-3 Satin Chrome**

## Clamps for wide panels - Top/bottom supports for panels wider than the distance between cables

Single



Double

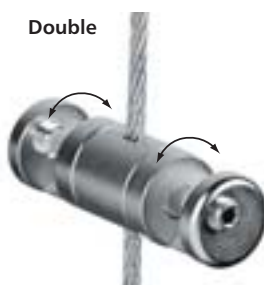

- adjustable to any angle
- can be locked into position

Item Code: Finish:

**Single  
CG12-3 Satin Chrome**

**Double  
CG22-3 Satin Chrome**

## Supports for panels with holes

For panels 5-6mm thick

Single



Double



- hole size **6mm** diameter
- supports for panels up to **20mm** thick available on request

Item Code: Finish:

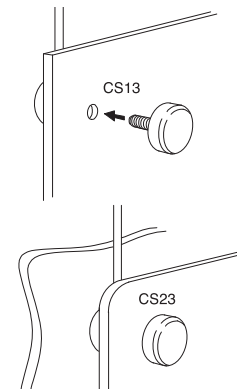

**Single  
CS13-3 Satin Chrome**

**Double  
CS23-3 Satin Chrome**



Full dimensions - p74

Standard finish satin chrome, all other finishes on request

Polished Chrome:  Polished Brass: 

# Panel & shelf supports - 3mm cable

## Multi-position clamps for panels and shelves

### For panels up to 7mm thick

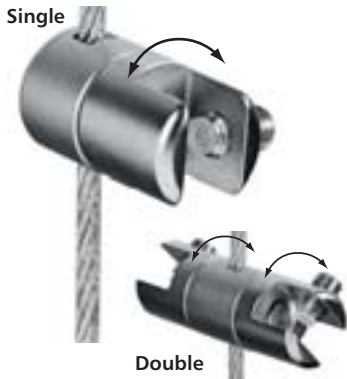

- adjustable to any angle
- can be locked into position

Item Code: Finish:

**Single**  
CG11-3 Satin Chrome

**Double**  
CG21-3 Satin Chrome

### For panels up to 10mm thick

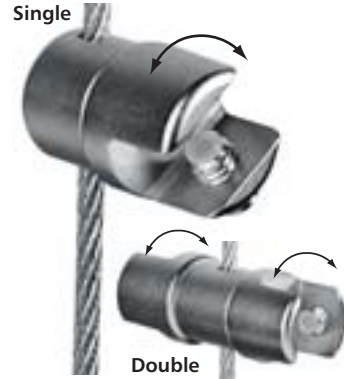

- adjustable to any angle
- can be locked into position

Item Code: Finish:

**Single**  
CG13-3 Satin Chrome

**Double**  
CG23-3 Satin Chrome

## Clamp for glass shelves

### For panels up to 12.7mm thick



Item Code: Finish:

CG15-3 Satin Chrome

## Under-shelf support



- locates under shelf
- shelf is drilled - hole size **10mm**
- inconspicuous

Item Code: Finish:

CS01-3 Satin Chrome

## Supports for wooden or glass shelves

### Shelf support



- adjustable to any angle of slope
- can be locked into position
- for glass shelves add ref. P08 (see right)

Item Code: Finish:

**Single**  
CS11-3 Satin Chrome

**Double**  
CS21-3 Satin Chrome

### Screw to retain glass shelves



- Used with CS11-3 or CS21-3 to hold **6mm** thick as standard
- flush finish
- plastic insert to protect glass
- hole **6mm** dia, **6mm** thick glass
- hole **12mm** from the edge of glass

Item Code: Finish:

P08 Satin Chrome

## Supports for screw fix panels



- support for any item fitted with boss fitting P02
- perfect to support hanging rails - page 47

Item Code: Finish:

CS03-3 Satin Chrome

### P02 Boss

- Boss for use with supports CS03/CS04
- use with up to No. 10 countersunk wood screw or bolt

Item Code: Finish:

P02 Nickel

## Hooks

### Hook for panels up to 3mm thick with holes



Item Code: Finish:

**Single**  
CH01-3 Satin Chrome

**Double**  
CH02-3 Satin Chrome

# Installation accessories for cable & rod installations

## Brackets

### Single wall bracket

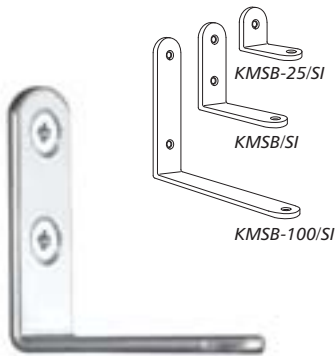

- available in 3 sizes
- all units can be fitted to the wall using up to no 10 screws
- supplied with nut and bolt to connect cable/rod to bracket

Size:  
**KMSB-25/SI:** 30mm height, 35mm depth, cable fixing: 25mm from wall  
**KMSB/SI:** 60mm height, 60mm depth, cable fixing: 50mm from wall  
**KMSB-100/SI:** 110mm height, 110mm depth, cable fixing: 100mm from wall

Item Code: Finish:

<b>KMSB-25/SI</b>	<b>Silver</b>
<b>KMSB/SI</b>	<b>Silver</b>
<b>KMSB-100/SI</b>	<b>Silver</b>

### Triangular wall bracket

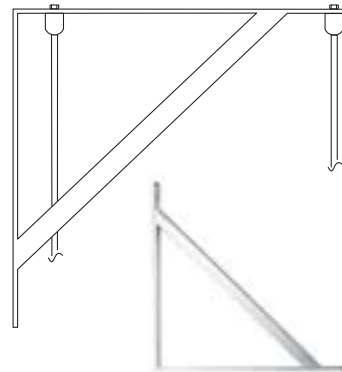

- supplied with 2 nuts and bolts to connect cables/rods to bracket
- supports 2 cables/rods 300mm apart
- hi-tech appearance
- can be used as a canopy or sign support

Size: 350mm height, 350mm depth, cables/rods project 40mm and 340mm from the wall

Item Code: Finish:

<b>KMDB/SI</b>	<b>Silver</b>
----------------	---------------

## Channels and toggle fittings

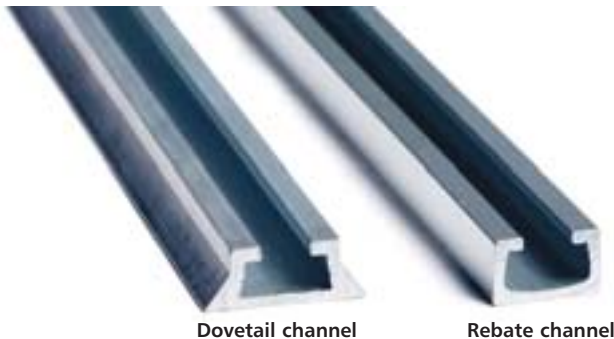

Dovetail channel

Rebate channel

### 3m dovetail channel

- for ceiling, floor or wall mounting
- makes cables/rods fully moveable
- stylish appearance
- NB order suitable toggle to connect cable/rod to the channel (see below)

Item Code: Finish:

<b>ACD</b>	<b>3m Silver</b>
ACD-2	2m silver
ACD-1	1m silver

### 3m rebate channel

- for rebating into floor or shelves with a flush finish
- makes cables/rods fully moveable
- NB order suitable toggle to connect cable/rod to the channel (see below)

Item Code: Finish:

<b>AC</b>	<b>Silver</b>
-----------	---------------

### 3m double sided channel



- for wall mounting with wall brackets and toggles

Item Code: Finish:

<b>ACL</b>	<b>Silver</b>
------------	---------------

### Quick fit cable



- cable design to be used with channel top and bottom
- includes 4m of cable, 2 quick fit toggles & spring tensioner

NB Not to be used with lighting

Item Code: Finish:

<b>CQQ</b>	<b>Satin Chrome</b>
------------	---------------------

### Toggle



AT

### Easy fit toggle



K1008S-M5

Item Code: Finish:

<b>AT</b>	<b>Silver</b>
-----------	---------------

- for fixing cables/rods to channels
- can be used with all top and bottom fittings
- supplied complete with allen key, 12mm and 14mm long screws

Item Code: Finish:

<b>K1008S-M5</b>	<b>Silver</b>
------------------	---------------

### Quick fit toggle



- brass toggle that screws into the top end of a cable/rod or wall fitting
- fits directly into almost any make of channel
- invisible when used

Item Code: Finish:

<b>PC01-Q</b>	<b>Brass for cable</b>
<b>PR01-Q</b>	<b>Brass for rod</b>

## Isolators

Add isolators when using channel or installing into metal ceilings or floors

### Top isolator

- Black nylon for cables, white nylon for rods



Top Isolator

#### Top isolator

Code:	
PC01/I	For cables
PR01/I	For rods

### Bottom isolator

- in 3 nylon sections

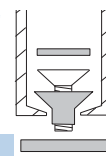

Bottom Isolator

#### Bottom isolator

Code:	
SP/I/S	For cables & rods

### In-line rod isolator

- insert when metal accessories touch both rods to avoid fusing



#### In-line isolator

Code:	
L/IJ	For 6mm rods

Full dimensions - p74

Polished Chrome: Polished Brass:

# Channel installation ideas for cable & rod installations

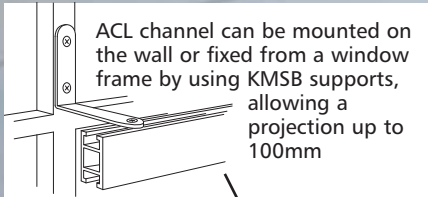

Channel solves many installation challenges:

- use channel when you wish to change the poster sizes and need different cable/rod centres
- use channel to create a feature area
- use channel to bring the display away from the wall or window
- use channel to bridge over a poor fixing area
- channel allows tremendous fixing flexibility. You can position cables anywhere along their length

Bottom rod fitting with AT toggle



ACL channel with quick fit cable (ref: CQQ)

# Tools and spares

## Cleaners



### Glass cleaner

- crystal clear finish, advanced formulation, high purity and non-abrasive

Item Code:

**CL/G 1 litre**



### Acrylic cleaner

- anti-static, polycarbonate, smear free

Item Code:

**CL/A 1 litre**  
**CL.5/A 500ml**

NB: solvent based cleaners (such as polish) will mark and possibly craze or damage acrylic, so we strongly recommend you use this acrylic cleaner

## Tools



### Allen keys

- ensure you have the correct allen key for your support - see page 74

Item Code: Size:

**AK1.5 1.5mm**  
**AK2.0 2.0mm**  
**AK2.5 2.5mm**  
**AK3.0 3.0mm**  
**AK4.0 4.0mm**  
**AK5.0 5.0mm**  
**AK6.0 6.0mm**



### Hex driver

- increases the speed of your installation

Item Code: Size:

**HD1.5 1.5mm**  
**HD2.0 2.0mm**  
**HD2.5 2.5mm**  
**HD3.0 3.0mm**  
**HD4.0 4.0mm**  
**HD5.0 5.0mm**

## Screws and fixings

### Small screws

- for use with WM12

Item Code:

**WS6X1 No. 6 x 1**  
**WS6X1.5 No. 6 x 1.5**

- minimum order quantity - 100



### Screws for channel

- use to install channel to ceiling/floor

Item Code:

**WS8X1 No. 8 x 1**  
**WS8X1.5 No. 8 x 1.5**



### Screws for cable/rod

- use to install cables/rods

Item Code:

**WS10X1 No. 10 x 1**  
**WS10X1.5 No. 10 x 1.5**

### Grubscrews for fittings

- spare grubscrews for use with fittings

Item Code:

**P13G/S M3 x 3mm**  
**P12 M3 x 6mm**  
**P11 M5 x 6mm**  
**P16 M4 x 6mm**  
**P18 M4 x 4mm**

### Nylon tipped screws

- protects glass and acrylic



Item Code:

**P10 M6 x 10mm**

### Interaset

- use to fix into plasterboard on ceilings or walls



Item Code:

**IS545 M5 x 45mm**

### Wallplugs

- for 8-10mm screws



Item Code:

**WPR Red**

## Miscellaneous



### Spirit level

- horizontal and vertical vial to allow perfect levelling

Item Code:

**SPL**

### Bare cable

- 1.5mm diameter cable  
- available in 5 lengths  
- supplied with copper crimps

Item Code: Length:

**BC1 1m**  
**BC2 2m**  
**BC3 3m**  
**BC4 4m**  
**BC5 5m**

Pictures for illustrations only

Full dimensions - p74

NO RESPONSIBILITY IS TAKEN FOR USING THE INCORRECT FIXING IN THE WALL/CEILING. IF IN DOUBT - PLEASE ASK.

Ceiling fitting



Cover cap



Rod



Bottom cover



Floor fitting



# Rod systems

dynamic  
strong  
visual  
statement  
highest  
quality



Rod systems to suit your design and budget

- 3mm rods support up to 60kg
- 6mm & 10mm rods can support up to 200kg
- Greater stability than the cable systems, with a dynamic yet elegant look
- Designed and manufactured to the highest possible standards of quality
- Life time guarantee on all metal components
- Extensive range of components and accessories ensure complete design flexibility
- Ideal for vertical and horizontal presentations
- Easy to install with an installation service available if required
- Available in standard finish - satin chrome. Polished chrome, brass and special finishes are available on request



# 3mm rod - fitting options

## Ceiling to floor fitting...

### Screw fix to ceiling/floor

- designed for use where displays are not changed often or where there is plenty of access to change posters
- fittings screw directly into ceiling/floor
- supplied with **3m** long rod, threaded at both ends



Item Code: *Finish:*  
**RBCF3 Satin Chrome**

### Toggle fitting to fit into channel

- for fast, flexible installations, use this toggle option
- displays fitted into channel can be easily relocated to take different poster sizes
- faster to install on difficult ceilings
- supplied with **3m** long rod, threaded at both ends



Item Code: *Finish:*  
**RBTF3 Satin Chrome**

## Suspended rods - from wall or ceiling

### Suspend from ceiling or wall with ball bearing fitting

- fitting available with or without toggle
- either screws directly into wall or ceiling or order fitting with toggle to fit into channel or freestanding units.
- ideal for display windows, close to the glass
- allows the display to be moved at an angle, giving access for window cleaning and changing displays
- highly practical fitting with end cap
- perfect for displays that are changed frequently

RB1  
standard  
fitting



RBT1  
with AT  
toggle  
for  
fixing  
into  
channel



15mm

### Screw-in fitting:

Item Code:	Finish:	Rod Length
RB1	Satin Chrome	1m
RB2	Satin Chrome	2m
RB3	Satin Chrome	3m

### With quick fit toggle fitting for use in channels:

Item Code:	Finish:	Rod Length
RBT1	Satin Chrome	1m
RBT2	Satin Chrome	2m
RBT3	Satin Chrome	3m

See page 26 for channel options  
See page 61 for freestanding frames



See 3mm kits on page 9.  
For more information on the  
full range, please ring  
for details

# Clamps - 3mm rod

## Vertical clamps

For panels up to 4mm thick

- non-removable panel clamp for panels up to 4mm thick



Item Code: Finish:

<b>Single</b>	
<b>CG03-3</b>	<b>Satin Chrome</b>
<b>Double</b>	
<b>CG04-3</b>	<b>Satin Chrome</b>



For panels up to 7mm thick:



Item Code: Finish:

<b>CG01-3</b>	<b>Satin Chrome</b>
---------------	---------------------

For panels up to 12.7mm thick:



Item Code: Finish:

<b>CG14-3</b>	<b>Satin Chrome</b>
---------------	---------------------

## Horizontal bar



### Horizontal 10mm bar

- 10mm bar designed to take 4 x 3mm rods at 244mm rod centres, which can be used with CG03-3 or CG04-4 to hold easy access pockets  
- overall length 764mm  
- rod centres 732mm

Item Code: Finish:

<b>HR10-3</b>	<b>Satin Chrome</b>
---------------	---------------------

### End caps for 10mm bar



- add two REC-10 for each horizontal bar ordered

Item Code: Finish:

<b>REC-10</b>	<b>Satin Chrome</b>
---------------	---------------------

## Multi-position clamps for panels and shelves

For panels up to 7mm thick

- adjustable to any angle  
- can be locked into position



Item Code: Finish:

<b>Single</b>	
<b>CG11-3</b>	<b>Satin Chrome</b>
<b>Double</b>	
<b>CG21-3</b>	<b>Satin Chrome</b>

For panels up to 10mm thick

- adjustable to any angle  
- can be locked into position

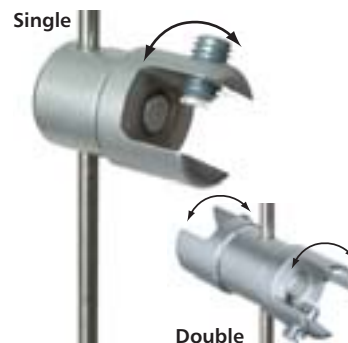

Item Code: Finish:

<b>Single</b>	
<b>CG13-3</b>	<b>Satin Chrome</b>
<b>Double</b>	
<b>CG23-3</b>	<b>Satin Chrome</b>

## Clamps for wide panels

- Top/bottom supports for panels wider than the distance between cables  
- adjustable to any angle  
- can be locked into position

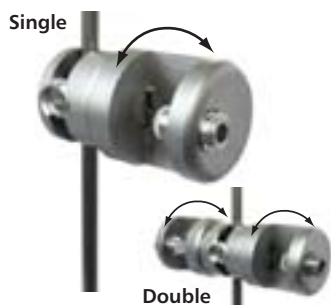

Item Code: Finish:

<b>Single</b>	
<b>CG12-3</b>	<b>Satin Chrome</b>
<b>Double</b>	
<b>CG22-3</b>	<b>Satin Chrome</b>

## Supports for panels with holes

For panels 5-6mm thick

- hole size 6mm diameter  
- supports for panels up to 20mm thick available on request



Item Code: Finish:

<b>Single</b>	
<b>CS13-3</b>	<b>Satin Chrome</b>
<b>Double</b>	
<b>CS23-3</b>	<b>Satin Chrome</b>

# Supports - 3mm rod

## Multi-position supports to hold rods

### Support to hold 6mm rods



- holds **6mm** diameter rod at any angle
- rods will hold acrylic pockets, leaflet holders, banners & graphics
- can be locked into position

Item Code: Finish:  
**RR01-3/6 Satin Chrome**

### Support to hold 10mm rods

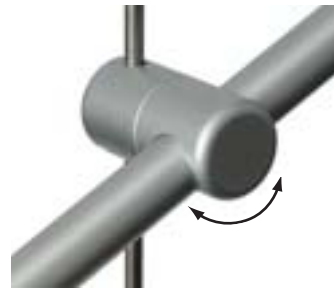

- holds **10mm** diameter rod at any angle
- can be locked into position

Item Code: Finish:  
**RR01-3/10 Satin Chrome**

## Hooks

### Hook for panels up to 3mm thick with holes

Single



Double

Item Code: Finish:  
**Single**  
**CH01-3 Satin Chrome**  
**Double**  
**CH02-3 Satin Chrome**

### Picture hook



- can also be used on **3mm** cable

Item Code: Finish:  
**CS12-3 Satin Chrome**

## Under-shelf support



- locates under shelf
- for shelf with **10mm** hole
- shelf is drilled
- inconspicuous

Item Code: Finish:  
**CS01-3 Satin Chrome**

## Clamp for glass shelves



For panels up to **12.7mm** thick

Item Code: Finish:  
**CG15-3 Satin Chrome**

## Rod support for 6mm rod



- for 6mm diameter rods
- rods will hold acrylic pockets, leaflet holders, banners & graphics

Item Code: Finish:  
**CS05-3 Satin Chrome**

## Supports for screw fix panels



- Support for any item fitted with boss fitting P02
- perfect to support hanging rails

Item Code: Finish:  
**CS03-3 Satin Chrome**

Item Code: Finish:  
**P02 Nickel**

## Supports for wooden or glass shelves

### Shelf support

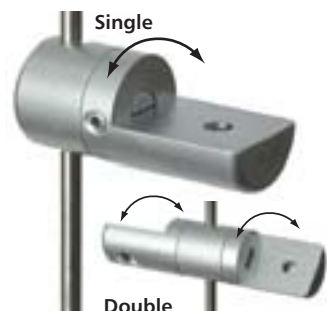

Double

- adjustable to any angle of slope
- can be locked into position
- for glass shelves add ref. P08 (see right)

Item Code: Finish:  
**Single**  
**CS11-3 Satin Chrome**  
**Double**  
**CS21-3 Satin Chrome**

### Screw to retain glass shelves



- Used with CS11-3 or CS21-3 to hold **6mm** thick as standard
- flush finish
- plastic insert to protect glass
- hole **6mm** dia, **6mm** thick glass
- hole **12mm** from the edge of glass

Item Code: Finish:  
**P08 Satin Chrome**

# 6mm rod - fitting options

## 6mm rods and end caps

### Threaded rod - both ends



- 1.5m rod, left hand threaded at both ends
- rods can be joined together

Item Code: Finish:

<b>R1500</b>	<b>Stainless steel</b>
--------------	------------------------

### Threaded rod - one end only



- 0.5m rod, left hand threaded at one end, domed at the other

Item Code: Finish:

<b>R500</b>	<b>Stainless steel</b>
-------------	------------------------

### Unthreaded rod



- available in 0.5m and 1m lengths

Item Code: Finish:

<b>0.5m</b>	
<b>R500P</b>	<b>Stainless steel</b>
<b>1m</b>	
<b>R1000P</b>	<b>Stainless steel</b>

### Rod end caps



Item Code: Finish:

<b>End cap for 6mm rod</b>	
<b>REC</b>	<b>Satin Chrome</b>
<b>Black PVC end cap for 6mm rod</b>	
<b>REC-P/BL</b>	<b>Black</b>

## Rod fitting options

### Top/bottom fitting for rods



Item Code: Finish:

<b>RAS</b>	<b>Satin Chrome</b>
------------	---------------------

### Angled top fitting plus bottom floor fitting

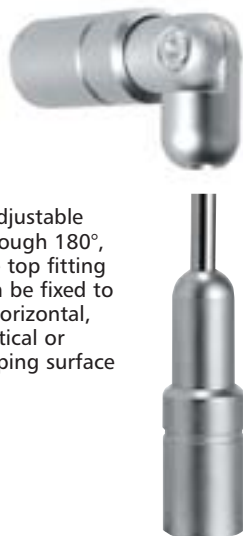

- adjustable through 180°, the top fitting can be fixed to a horizontal, vertical or sloping surface

Item Code: Finish:

<b>RAAS</b>	<b>Satin Chrome</b>
-------------	---------------------

### Rod ceiling fittings



Screw fit      Push fit

- available as screw fit - use with threaded rod or push fit with grub screw

Item Code: Finish:

<b>Screw fit</b>	
<b>RS</b>	<b>Satin Chrome</b>
<b>Push fit</b>	
<b>RP</b>	<b>Satin Chrome</b>

### Angled fittings



- available as screw fit - use with threaded rod or push fit with grub screw
- adjustable through 180°

Item Code: Finish:

<b>Screw fit</b>	
<b>RSA</b>	<b>Satin Chrome</b>
<b>Push fit</b>	
<b>RPA</b>	<b>Satin Chrome</b>

### Wall fitting - projects 24mm

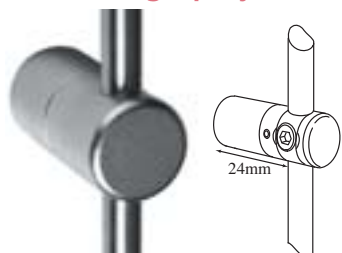

- use vertical or horizontal
- use up to no.10 screw to fix

Item Code: Finish:

<b>WM11</b>	<b>Satin Chrome</b>
-------------	---------------------

### Wall/panel fitting - projects 10mm



- use vertical or horizontal
- support to be used with Boss ref. P02
- minimum panel thickness 12mm
- use up to no. 8 screw to fix

Item Code: Finish:

<b>RS03</b>	<b>Satin Chrome</b>
<b>P02</b>	<b>Nickel</b>

See page 43 for Acrylic Hook-on Accessories and page 49 for Hook-on Shelves

Full dimensions - p74

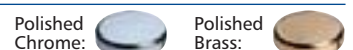

# Panel clamps - 6mm rod

## Vertical clamps

For panels up to 7mm thick:



Item Code: Finish:

<b>Single</b>	
<b>RG01</b>	<b>Satin Chrome</b>
<b>Double</b>	
<b>RG02</b>	<b>Satin Chrome</b>

For panels up to 7mm thick - non-removable

- supports signs from the side



Item Code: Finish:

<b>RGN01</b>	<b>Satin Chrome</b>
--------------	---------------------

## Multi-position clamps

For panels up to 7mm thick:



- adjustable to any angle
- can be locked into position

Item Code: Finish:

<b>Single</b>	
<b>RG11</b>	<b>Satin Chrome</b>
<b>Double</b>	
<b>RG21</b>	<b>Satin Chrome</b>

For panels up to 10mm thick

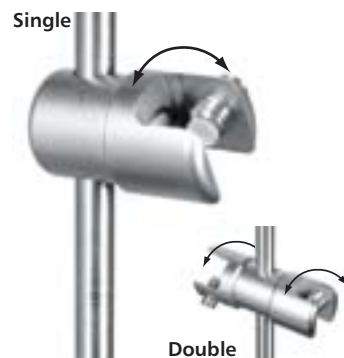

- adjustable to any angle
- can be locked into position

Item Code: Finish:

<b>Single</b>	
<b>RG13</b>	<b>Satin Chrome</b>
<b>Double</b>	
<b>RG23</b>	<b>Satin Chrome</b>

## Multi-position clamps for wide panels

For panels up to 7mm thick:

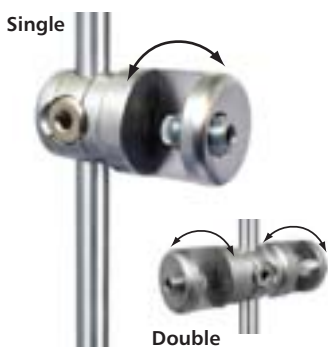

- top/bottom clamps for panels wider than the distance between rods
- adjustable to any angle
- can be locked into position

Item Code: Finish:

<b>Single</b>	
<b>RG12</b>	<b>Satin Chrome</b>
<b>Double</b>	
<b>RG22</b>	<b>Satin Chrome</b>

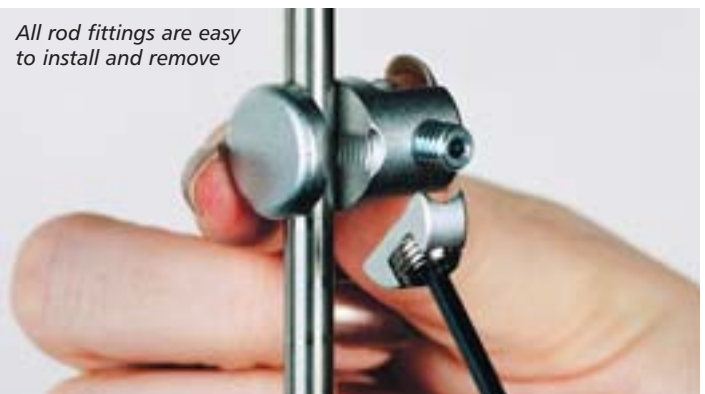

## Supports for panels with holes

For panels 5-6mm thick:



- to hold standard panels **5-6mm** thick
- hole size **6mm** diameter
- supports for panels up to **20mm** thick are also available
- see ordering information on the right

Item Code: Finish:

<b>Single</b>	
<b>RS13</b>	<b>Satin Chrome</b>
<b>Double</b>	
<b>RS23</b>	<b>Satin Chrome</b>

**RS13 & RS23**  
for extra thick panels up to 20mm, specify size required. Add £1.00 to price shown.

Ref example:  
RS13/S

Full dimensions - p74

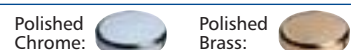

# Supports - 6mm rod

## Supports for screw fix panels



### Support

- support for any item fitted with boss fitting P02 - see right

Item Code: Finish:

**Single**  
RS03 Satin Chrome

**Double**  
RS04 Satin Chrome



### P02 Boss

- Boss for use with supports RS03/RS04  
- use with up to No. 10 countersunk wood screw or bolt

Item Code: Finish:

P02 Nickel



### P02-2 Boss

- as above, but double sided, to attach two components together

Item Code: Finish:

P02-2 Nickel

## Sign support

For panels up to 7mm thick



- Supports signs from above

Item Code: Finish:

RG05 Satin Chrome

Light weight card signs only (sign should weigh 200g max.)  
See page 18 for heavy sign systems.



## Hooks

Hook for panels up to 3mm thick with holes

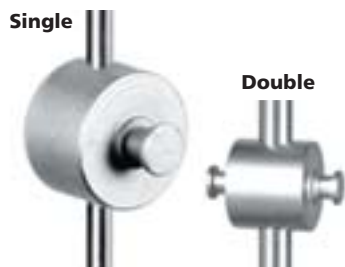

Item Code: Finish:

**Single**  
RH01 Satin Chrome

**Double**  
RH02 Satin Chrome

Picture hooks



Item Code: Finish:

**Single**  
RS12 Satin Chrome

**Double**  
RS22 Satin Chrome

## Under-shelf support



- locates under shelf  
- shelf requires 10mm diameter hole  
- non-removable support

Item Code: Finish:

**Single**  
RS01 Satin Chrome



Full dimensions - p74

Polished Chrome:  Polished Brass: 

# Shelf supports - 6mm rod

## Supports for wooden or glass shelves

### Shelf support

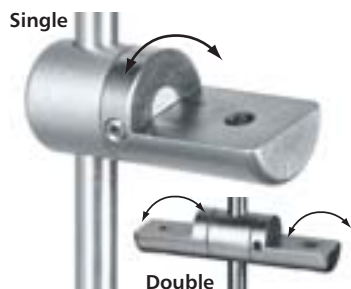

- adjustable to any angle of slope
- can be locked into position
- for glass shelves add ref. P08 (see right)

Item Code: Finish:

<b>Single</b>	
<b>RS11</b>	<b>Satin Chrome</b>
<b>Double</b>	
<b>RS21</b>	<b>Satin Chrome</b>

### Screw to retain glass shelves



- Used on RS11 or RS21 to hold **6mm** thick as standard
- flush finish
  - plastic insert to protect glass
  - hole **6mm** dia, **6mm** thick glass
  - hole **12mm** from edge of glass

Item Code: Finish:

<b>P08</b>	<b>Satin Chrome</b>
------------	---------------------

## Clamps for glass shelves and panels

### Clamp for glass shelves up to 7mm thick



- for glass shelves without holes

Item Code: Finish:

<b>Single</b>	
<b>RG06</b>	<b>Satin Chrome</b>
<b>Double</b>	
<b>RG07</b>	<b>Satin Chrome</b>



## Multi-position clamps for glass shelves and panels

### Multi-position clamp for glass shelves and panels up to 7mm thick

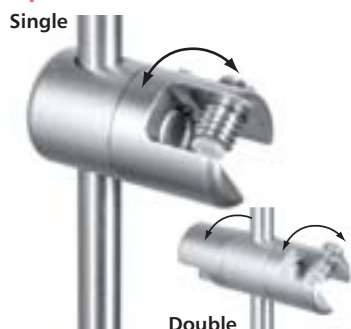

- adjustable to any angle
- can be locked into position

Item Code: Finish:

<b>Single</b>	
<b>RG11</b>	<b>Satin Chrome</b>
<b>Double</b>	
<b>RG21</b>	<b>Satin Chrome</b>

### Multi-position clamp for glass shelves and panels up to 10mm thick

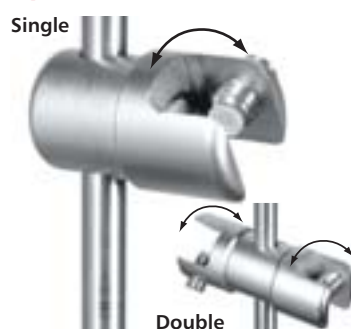

- adjustable to any angle
- can be locked into position

Item Code: Finish:

<b>Single</b>	
<b>RG13</b>	<b>Satin Chrome</b>
<b>Double</b>	
<b>RG23</b>	<b>Satin Chrome</b>

## Supports to hold rods

### Rod support



- for **6mm** diameter rods
- rods will hold acrylic pockets, leaflet holders, banners & graphics etc

Item Code: Finish:

<b>Single</b>	
<b>RS05</b>	<b>Satin Chrome</b>
<b>Double</b>	
<b>RS06</b>	<b>Satin Chrome</b>

### Rod support - Multi-position



- to hold **6mm** rod
- support for rods at any angle
- can be locked into position

Item Code: Finish:

<b>RR01</b>	<b>Satin Chrome</b>
-------------	---------------------

See page 33 for 6mm Diameter Rods

See page 43 for Acrylic Hook-on Accessories

Full dimensions - p74

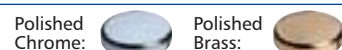

# 10mm rod - fitting options

## 10mm threaded rod

### Threaded rod - both ends



- 10mm rod, right hand threaded
- available in .5m, 1m and 1.5m lengths

Item Code: Finish:

**R1500-10** Stainless steel  
**R1000-10** Stainless steel  
**R500-10** Stainless steel

### Rod end caps



Item Code: Finish:

**REC-10** Satin Chrome

## Rod fitting options

### Top/bottom fitting



Item Code: Finish:

**RAS-10** Satin Chrome

### Ceiling fitting



- screw fix for use with threaded rod

Item Code: Finish:

**RS-10** Satin Chrome

### Wall mounted fittings - vertical or horizontal

- wall mounted fixing to hold the rod **27mm** from the wall



Item Code: Finish:

**WM11-10** Satin Chrome

- wall mounted fixing to hold the rod **50mm** from the wall
- ideal for use with narrow shelves



Item Code: Finish:

**WM11L-10** Satin Chrome

## In-line connector



- allows a 6mm horizontal rod to be fitted flush to the vertical 10mm rod

Item Code: Finish:

**RC10-6** Satin Chrome

## Decorative cover disc - thread through

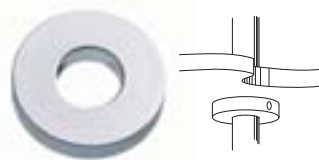

- can be used with any standard 6mm or 10mm diameter rod
- use below false ceiling to hide hole, giving a professional finish

Item Code: Finish:

**CD-10** Satin Chrome

## Extra strong ceiling/wall fitting



- heavy duty ceiling/wall support with 3 screw holes for extra secure fixing

Item Code: Finish:

**HDS** Satin Chrome

## Decorative support plate



- can be used with any standard ceiling fitting or wall mount

Item Code: Finish:

**P01-PC01** Satin Chrome

**NB: All 10mm rod fittings shown here are NON-REMOVABLE and are threaded onto the rod at the time of installation**

Full dimensions - p74

# Panel clamps - 10mm rod

## Vertical clamps

For panels up to 7mm thick:

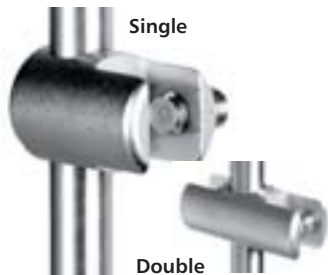

Item Code: Finish:

Single	
RG01-10	Satin Chrome
Double	
RG02-10	Satin Chrome

For panels up to 12.7mm thick:



Item Code: Finish:

RG14-10	Satin Chrome
---------	--------------

## Multi-position clamps

For panels up to 7mm thick:

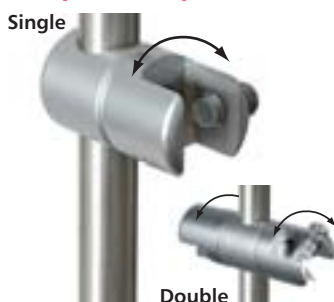

- adjustable to any angle
- can be locked into position

Item Code: Finish:

Single	
RG11-10	Satin Chrome
Double	
RG21-10	Satin Chrome

For panels up to 10mm thick



- adjustable to any angle
- can be locked into position

Item Code: Finish:

Single	
RG13-10	Satin Chrome
Double	
RG23-10	Satin Chrome

## Multi-position clamps for wide panels

For panels up to 7mm thick

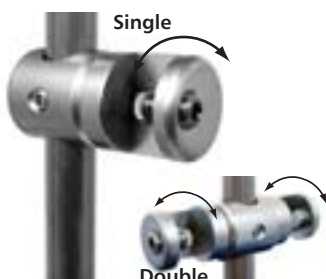

- top/bottom supports for panels wider than the distance between rods
- adjustable to any angle
- can be locked into position

Item Code: Finish:

Single	
RG12-10	Satin Chrome
Double	
RG22-10	Satin Chrome

## Supports for panels with holes

For panels 5-6mm thick



- hole size **6mm** diameter
- to hold standard panels **5-6mm** thick
- for extra thick panels up to 20mm, specify size required. Add £1.00 to price shown

Item Code: Finish:

Single	
RS13-10	Satin Chrome
Double	
RS23-10	Satin Chrome

## Hooks

Hook for panels up to 3mm thick with holes



Item Code: Finish:

Single	
RH01-10	Satin Chrome
Double	
RH02-10	Satin Chrome

Picture hook



Item Code: Finish:

RS12-10	Satin Chrome
---------	--------------

**NB: All 10mm rod fittings shown here are NON-REMOVABLE and are threaded onto the rod at the time of installation**

Full dimensions - p74

# Supports - 10mm rod

## Supports for wooden or glass shelves

### Shelf support



- adjustable to any angle of slope
- can be locked into position
- for glass shelves add ref. P08 (see right)

Item Code: Finish:

<b>Single</b>	
<b>RS11-10</b>	<b>Satin Chrome</b>
<b>Double</b>	
<b>RS21-10</b>	<b>Satin Chrome</b>

### Screw to retain glass shelves



- Used on on RS11-10 or RS21-10 to hold **6mm** thick as standard
- flush finish
- plastic insert to protect glass
- hole **6mm** dia, **6mm** thick glass
- hole **12mm** from the edge of glass

Item Code: Finish:

<b>P08</b>	<b>Satin Chrome</b>
------------	---------------------

## Clamp for glass shelves and panels

### Clamp for glass shelves up to 7mm thick



- for glass shelves without holes

Item Code: Finish:

<b>Single</b>	
<b>RG06-10</b>	<b>Satin Chrome</b>
<b>Double</b>	
<b>RG07-10</b>	<b>Satin Chrome</b>

## Supports to hold rods

### Rod support for 6mm rod



- to take **6mm** diameter rods
- rods will hold acrylic pockets, leaflet holders, banners & graphics

Item Code: Finish:

<b>Single</b>	
<b>RS05-10</b>	<b>Satin Chrome</b>
<b>Double</b>	
<b>RS06-10</b>	<b>Satin Chrome</b>

## Supports for screw fix panels



### Support

- support for any item fitted with boss fitting P02 - see right

Item Code: Finish:

<b>Single</b>	
<b>RS03-10</b>	<b>Satin Chrome</b>
<b>Double</b>	
<b>RS04-10</b>	<b>Satin Chrome</b>



### P02 Boss

- Boss for use with supports RS03-10/RS04-10
- use with up to No. 10 countersunk wood screw or bolt

Item Code: Finish:

<b>P02</b>	<b>Nickel</b>
------------	---------------

## Multi-positional supports to hold rods

### Support to hold 6mm rods



- to hold **6mm** diameter rods
- rods will hold acrylic pockets, leaflet holders, banners & graphics etc

Item Code: Finish:

<b>RR01/6-10</b>	<b>Satin Chrome</b>
------------------	---------------------

### Support to hold 10mm rods



- to hold **10mm** rod
- support for rods at any angle
- can be locked into position

Item Code: Finish:

<b>RR01-10</b>	<b>Satin Chrome</b>
----------------	---------------------

See page 33 for 6mm Diameter Rods. See page 43 for Acrylic Hook-on Accessories

**NB: All 10mm rod fittings shown here are NON-REMOVABLE and are threaded onto the rod at the time of installation**

Accessories can make an enormous difference to the power of your presentation. Create highly attractive hard-working projects

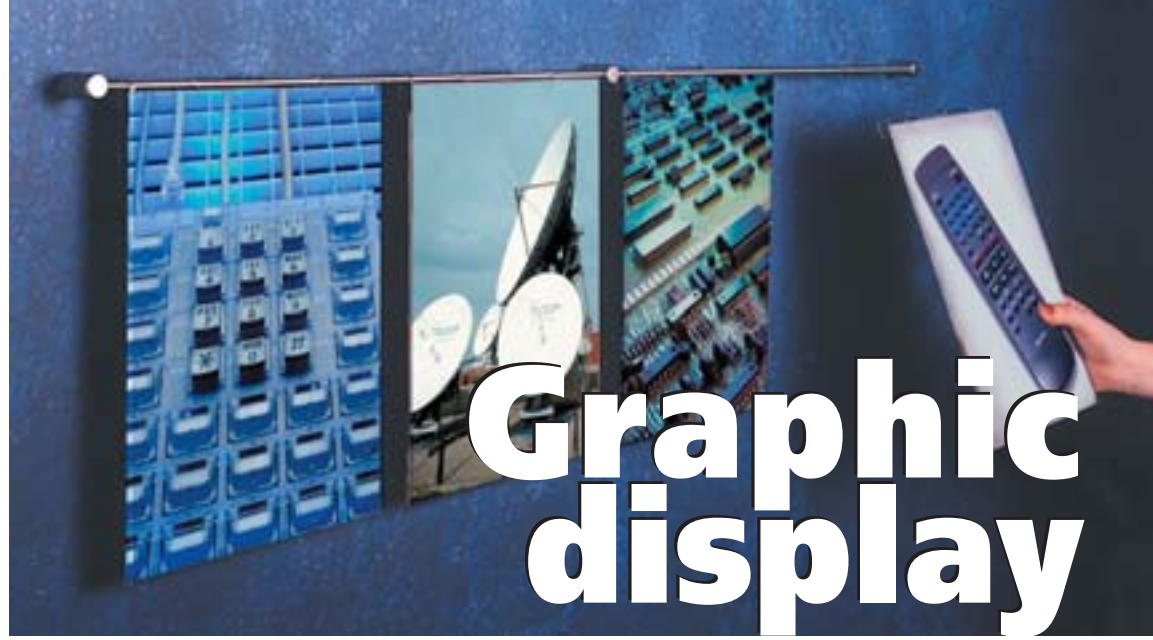

# Graphic display

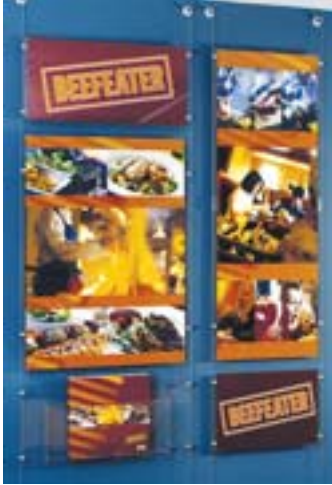

## Your choice of finishes & material

**More than just clear acrylic... be adventurous and turn a simple design into something spectacular...**

### Imagery...

#### Screen printing

Create high quality text and logo images.

#### Vinyl lettering

An inexpensive option, ideal for simple lettering.

### Acrylics...

**Non-reflective acrylic** - used to increase visibility in sunny windows or to reduce the glare from spot lighting.

**Silicone** - green edge, looks like glass.

**Sandblast effect** - looks like sandblasted glass and does not show dust. Creates impressive screens and background panels.

**Coloured acrylic** - solid colours create ideal background panels.



# Acrylic pockets & poster holders

A wide range of pocket types and sizes are available to suit any display requirement. Shown here are just some of the options available - if you want a special size or shape, please call to discuss your requirements.

## Easy access pockets

Portrait and landscape pockets in clear acrylic, available in a wide range of sizes.

- designed to be used with cable/rod systems or wall mounted supports (WM09, WM05-13 with WMS-2)



## Jumbo pockets

Double sided acrylic pocket designed to take very large posters. Made to order - please call for details.

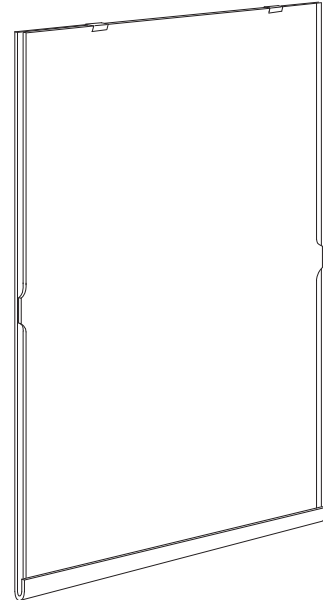

## 'C' shaped pockets

A poster display that has a decorative back panel which can be screen printed with logos or text. Back panel can be supplied straight or with decorative 'ragged' edge. Made to order only - please call.



## Easy access pockets



Portrait

- portrait and landscape pockets in clear acrylic with polished edges
- available in a wide range of sizes

### Portrait pockets

- A2, A1 and A0 are supplied with top clip as standard
- Sizes A5 and A4 are 2mm thick acrylic, all others are 3mm thick

Item Code:	Size:	1.5mm & 3mm Cable/Rod centre:	6mm Rod centre:	10mm Rod centre:
MA5PW	A5	182mm	186mm	190mm
MA4PW	A4	244mm	248mm	252mm
MA3PW	A3	331mm	335mm	339mm
MA2PW	A2	454mm	458mm	462mm
MA1PW	A1	628mm	632mm	636mm
MA0PW	A0 (2 part pocket)	875mm	879mm	883mm
M5070PW	500mm x 700mm	534mm	538mm	542mm
A2030PW	Double Crown (20" x 30")	542mm	546mm	550mm
A3040PW	Quad Crown (30" x 40")	796mm	800mm	804mm



Landscape

### Landscape pockets

- A2 and A1 are supplied with top clip as standard
- Sizes A5, A4 and A3 are 2mm thick acrylic, all others are 3mm thick

Item Code:	Size:	1.5mm & 3mm Cable/Rod centre:	6mm Rod centre:	10mm Rod centre:
MA5LW	A5	244mm	248mm	252mm
MA4LW	A4	331mm	335mm	339mm
MA3LW	A3	454mm	458mm	462mm
MA2LW	A2	628mm	632mm	636mm
MA1LW	A1	875mm	879mm	883mm

### Spare top clips

- for use with landscape and portrait easy access pockets

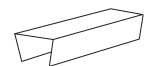

Item Code:  
MRC

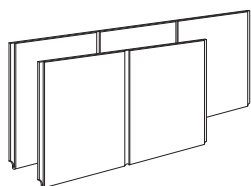

### Double and treble width pockets

- double and treble width A4 portrait pockets in 2mm thick clear acrylic

Item Code:	Size:	1.5mm & 3mm Cable/Rod centre:	6mm Rod centre:	10mm Rod centre:
M2A4PW	A4 x 2 pockets	466mm	470mm	474mm
M3A4PW	A4 x 3 pockets	688mm	692mm	696mm

- A3 landscape pocket to be used with M2A4PW above

Item Code:	Size:	1.5mm & 3mm Cable/Rod centre:	6mm Rod centre:	10mm Rod centre:
MA3LW-456	A3	466mm	470mm	474mm



Cable/rod centres shown refer to fixed position clamps only e.g. CG01, CG03 (p20), CG01-3, CG03-3 (p31), RG01 (p34), RG01-10 (p38)

# Acrylic pockets & poster holders

## Top fixing pocket

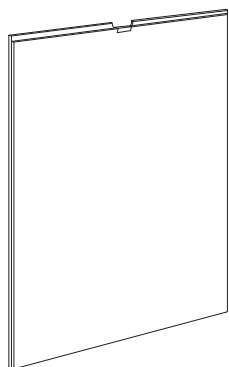

### Top fixing pockets

- designed to be suspended from the top
- 3mm thick acrylic, supplied with top clip
- use with KC2-CG05 (p18)

Item Code:      Size:

MA2HD      **A2**  
MA1HD      **A1**

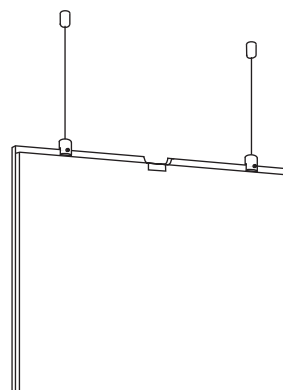

## Pocket frames - for suspension on cables



Solid natural beech frames that attach directly to the cables, with no additional fittings

- complete with U-shaped acrylic pockets
- all units double sided
- profile size: 22mm wide x 20mm deep

Item      Size:      1.5mm  
Code:      Cable centres:

WFA5      **A5**      182mm  
WFA4      **A4**      244mm  
WFA3      **A3**      331mm  
WFA2      **A2**      454mm

## Wall mounted easy access pockets with holes



- to be mounted directly onto wall
- A5 and A4 pockets are 2mm thick acrylic, all other sizes are 3mm thick
- use with WM05-13, WM05L-20 (p13)

### Portrait pockets with holes

Item Code:      Size:

MA5PW-WM      **A5**  
MA4PW-WM      **A4**  
MA3PW-WM      **A3**  
MA2PW-WM      **A2**  
MA1PW-WM      **A1**  
MA0PW-WM      **A0**

### Landscape pockets with holes

Item Code:      Size:

MA5LW-WM      **A5**  
MA4LW-WM      **A4**  
MA3LW-WM      **A3**  
MA2LW-WM      **A2**  
MA1LW-WM      **A1**  
MA0LW-WM      **A0**



## Wall mounted frameless acrylic poster holders

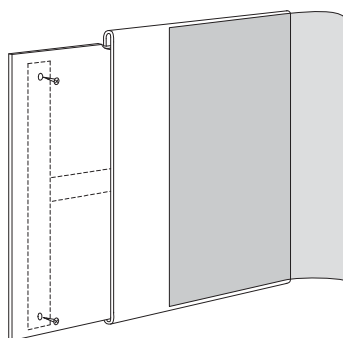

- two part pocket with a fixed back panel in foam board, which screws directly to the wall. Hook-on acrylic front creates a frameless poster display that is flat against the wall with no visible fixing
- no tools required to change the poster

### Portrait

Item Code:      Size:

AWPA4      **A4**  
AWPA3      **A3**  
AWPA2      **A2**  
AWPA1      **A1**

### Landscape

Item Code:      Size:

AWPA4L      **A4**  
AWPA3L      **A3**  
AWPA2L      **A2**



# Hook-on accessories for use on wall-mounted rods

## Hook-on easy access pockets



- pockets designed to be used with horizontal rods. Just hook on in desired position
- A5 and A4 pockets are 2mm thick acrylic, all other sizes are 3mm thick

### Portrait

Item Code: Size:

HA5P	<b>A5</b>
HA4P	<b>A4</b>
HA3P	<b>A3</b>
HA2P	<b>A2</b>

### Landscape

Item Code: Size:

HA5L	<b>A5</b>
HA4L	<b>A4</b>
HA3L	<b>A3</b>
HA2L	<b>A2</b>

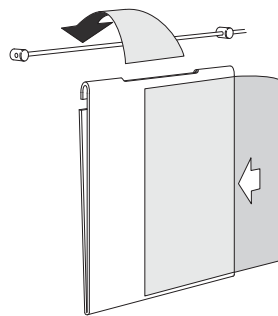

### L-shaped support

To be used with wall-mounted hook-on pockets, where WM11 supports have been used to fix rods to the wall

- keeps pockets hanging vertically
- supplied with double sided adhesive

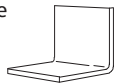

Item Code:

HAS

- available in kit of 4 x A4 portrait pockets, complete with 1m of 6mm diameter rod and wall fixings

### Kit - 4 x A4 portrait pockets

Item Code: Size:

KHA4W Kit **4 x A4**

## Hook-on leaflet dispensers



- A4 portrait hook-on leaflet dispenser. Just hook on in desired position
- 3mm thick acrylic, 40mm internal depth
- A4 sized as standard - other sizes on request

Item Code:

HA4D **A4**



KHA4D

- available in kit of 4 x A4 portrait dispensers, complete with 1m of 6mm diameter rod and wall fixings

### Kit - 4 x A4 portrait dispensers

Item Code: Size:

KHA4D **4 x A4**

## Hook-on sloping shelf with lip



- sloping shelves used with wall-mounted horizontal rods
- 3mm thick acrylic, 40mm deep lip
- supplied with triangular back support
- ideal for displaying literature or folded items

### Kits

- available in kits of 4 x A4 portrait shelves or 2 x A3 landscape shelves, complete with 1m of 6mm diameter rod and wall fixings

### Portrait

Item Code: Size:

HA4S **A4**

### Landscape

Item Code: Size:

HA3S **A3**

### Kit - 4 x A4 portrait shelves

Item Code: Size:

KHA4S **4 x A4**

### Kit - 2 x A3 landscape shelves

Item Code: Size:

KHA3S **2 x A3**



KHA4S



KHA3S

## Fixing systems

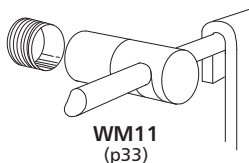

WM11  
(p33)

Hook-on wall mounted pockets/leaflet dispensers:

- fix to the wall with WM11 which will give a good solid fixing to any type of wall. Use R1000P for single bays and R1500 for continuous runs
- projects centre of rod 24mm away from the wall. Use HAS to ensure display hangs vertical
- fix WM11 support every 484mm on horizontal rod

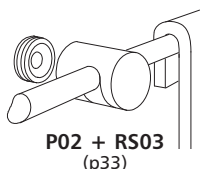

P02 + RS03  
(p33)

Wall mounted supports for hook-on shelves:

- use P02 + RS03 when fixing hook-on shelves. This support fits closely to the wall and allows the accessory to locate securely
- projects centre of rod 10mm away from the wall

# Leaflet dispensers for use on cable/rod systems

## A4 dispensers



Single A4  
MA4D

- leaflet dispensers to take A4 portrait leaflets
- 3mm thick acrylic. 2 x A4 versions have 4mm acrylic backs
- depth of pocket 40mm

### Single sided

Item Code:	Size:	1.5mm & 3mm Cable/Rod centre:	6mm Rod centre:	10mm Rod centre:
MA4D	Single A4	244mm	248mm	252mm
ADLA2	2 x A4	454mm	458mm	462mm
ADLA1	2 x A4	628mm	632mm	636mm

### Double sided

Item Code:	Size:	1.5mm & 3mm Cable/Rod centre:	6mm Rod centre:	10mm Rod centre:
MA4D-D	Single A4	244mm	248mm	252mm
ADLA2-D	2 x A4	454mm	458mm	462mm
ADLA1-D	2 x A4	628mm	632mm	636mm



2 x A4  
overall  
width A2  
ADLA2



2 x A4  
overall  
width A1  
ADLA1



## A5 dispensers



2 x A5  
overall width A2  
ADMA2

- leaflet dispensers to take A5 portrait leaflets
- 4mm acrylic back panel, 3mm acrylic front section
- depth of pocket 40mm

### Single sided

Item Code:	Size:	1.5mm & 3mm Cable/Rod centre:	6mm Rod centre:	10mm Rod centre:
ADMA2	2 x A5	454mm	458mm	462mm
ADMA1	3 x A5	628mm	632mm	636mm

### Double sided

Item Code:	Size:	1.5mm & 3mm Cable/Rod centre:	6mm Rod centre:	10mm Rod centre:
ADMA2-D	2 x A5	454mm	458mm	462mm
ADMA1-D	3 x A5	628mm	632mm	636mm



3 x A5  
overall width A1  
ADMA1

## 1/3rd A4 dispensers



4 x 1/3 A4  
overall width A2  
ADSA2

- leaflet dispensers to take 1/3rd A4 portrait leaflets
- 4mm acrylic back panel, 3mm acrylic front section
- depth of pocket 40mm

### Single sided

Item Code:	Size:	1.5mm & 3mm Cable/Rod centre:	6mm Rod centre:	10mm Rod centre:
ADSA2	4 x 1/3 A4	454mm	458mm	462mm
ADSA1	5 x 1/3 A4	628mm	632mm	636mm

### Double sided

Item Code:	Size:	1.5mm & 3mm Cable/Rod centre:	6mm Rod centre:	10mm Rod centre:
ADSA2-D	4 x 1/3 A4	454mm	458mm	462mm
ADSA1-D	5 x 1/3 A4	628mm	632mm	636mm



5 x DL  
overall width A1  
ADSA1

## Angled leaflet dispensers



- 3mm thick acrylic leaflet dispensers designed to take a variety of sizes
- with 40mm lip and triangular back support
- special sizes available on request

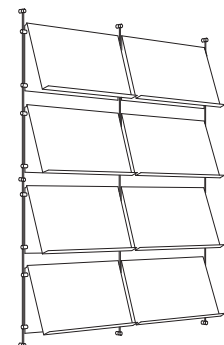
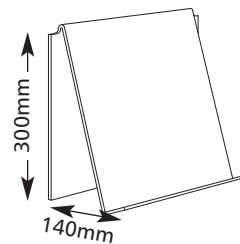

Item Code:	Size:	1.5mm & 3mm Cable/Rod centre:	6mm Rod centre:	10mm Rod centre:
ASA4P	A4 portrait	244mm	248mm	252mm
ASA4L	A4 landscape	331mm	335mm	339mm
ASA3L	A3 landscape	454mm	458mm	462mm

# Acrylic accessories

## Sloping shelves For use on cable/rod systems

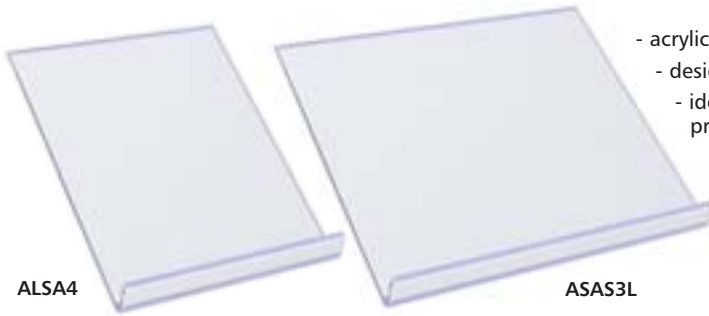

- acrylic shelf with lip at front edge
- designed to be supported by 4 cables or rods
- ideal for A4 leaflets/booklets and product presentations
- shelf height 330mm with front lip of 45mm
- choose from clear or silicon acrylic
- shelves are 5mm thick

ALSA4

ASAS3L

Shelves have been designed to be used with 150 mm spacing between front and back cable/rods. Use with multi-position supports - see pages 20, 25, 31, 34, 38.

Item Code: Size: Finish:

ALSA4	A4	Clear
ALSA4/S	A4	Silicon
ALSA3L	A3 landscape	Clear
ALSA3L/S	A3 landscape	Silicon



## Freestanding/wall mounted leaflet dispensers



- injection moulded plastic
- units can be linked together

Item Code: Size: Dimensions (mm):

A34D/I	1/3rd A4	104w x 200h
A234D-1	2 x 1/3rd A4	235w x 260h x 85mm d
A5D/I	A5	155w x 200h
A4D/I	A4	230w x 300h



A34D/I

A5D/I

A4D/I

A234D-1  
(freestanding only)

## Business card holder



- sold in packs of 36 only
- maximum card size: 90mm wide x 50mm high

Item Code: Finish:

ABCH	Clear
------	-------

## Freestanding menu/leaflet holders



MA4PF

MA5PF

- single sided, 2mm thick acrylic

Item Code: Size: Dimensions (mm):

MA5PF	A5	150w x 210h
MA4PF	A4	210w x 300h



MA4PF-D

MA5PF-D

- Double sided, 2mm thick acrylic

Item Code: Size: Dimensions (mm):

MA5PF-D	A5	148w x 220h
MA4PF-D	A4	210w x 307h

# Framed posters & A boards

## Click/Snap frames - 25mm



- quick and easy to open poster frame
- anti-glare PVC poster cover
- silver anodised finish
- no tools required to change poster

Item Code:	Size:	Poster dimensions:
CFA4	A4	210mm x 297mm
CFA3	A3	297mm x 420mm
CFA2	A2	420mm x 594mm
CFA1	A1	594mm x 841mm

## Security click/Snap frames - 25mm



- security frame will protect your poster
- frame is virtually impossible to open without lever tool

Item Code:	Size:	Poster dimensions:
CFSA4	A4	210mm x 297mm
CFSA3	A3	297mm x 420mm
CFSA2	A2	420mm x 594mm
CFSA1	A1	594mm x 841mm

Remember to order lever tool:

Item Code:
CFS-LT25

## Flex-A-Board



- extremely stable - stays in place even under heavy winds
- takes standard posters - quick and easy to change
- light weight, easy to carry, relocate, fold away and store
- snaps shut flat with magnetic catch

Item Code:	Size:	Poster dimensions:
MA2	A2	420mm x 594mm
MA1	A1	594mm x 841mm

## Flex-A-Board accessories



- protect your unit with an easy to use canvas slip-over cover
- protects your unit while being stored or transported

Item Code:	Size:
CPA2	A2
CPA1	A1
CPA0	A0

## Standard 'A' Boards



- fold away poster display
- quick and easy to change poster
- anti-glare poster cover

Item Code:	Size:	Poster dimensions:
AA2	A2	420mm x 594mm
AA1	A1	594mm x 841mm

# Banner & hanging rails

## Gotcha strips



Aluminium banner rail with clear plastic gripper strip. Fitted with PO2 supports ready to be used on 1.5mm and 3mm cable and on 3mm, 6mm and 10mm rods.

- quick and easy way to suspend large posters. The clear plastic strips simply clip the poster into position, holding it firmly in place.
- suspend banners from the top only or use floor to ceiling cables or rods to hold banners top and bottom - ensures perfect tension at all times.

- remember to order supports - see below



Item Code:	Size:
A-60	60" (1524mm)
A-48	48" (1219mm)
A-40	40" (1016mm)
A-36	36" (914mm)
A-24	24" (610mm)
A-12	12" (305mm)

Single



Double

### Supports

Remember to add supports for Gotcha strips. Available as single or double sided

- supports listed are in satin chrome finish

Item Code: Cable/rod:

Single	
CS03	1.5mm cable
CS03-3	3mm cable/rod
RS03	6mm rod
RS03-10	10mm rod

Item Code: Cable/rod:

Double	
CS04	1.5mm cable
RS04	6mm rod
RS04-10	10mm rod

## Banner rails



### 19mm diameter banner rails

- supplied with supports CS03/RS03 to fit directly onto 1.5mm cables/6mm rods. No additional fittings required
- Shorter lengths cut to size - add £1.00 (specify cable centres required)

Item Code:	Length:	Cable/rod centre:
BR19C-3/PC	3' (914mm)	944mm cable centres
BR19C-4/PC	4' (1219mm)	1250mm cable centres
BR19R-3/PC	3' (914mm)	944mm rod centres
BR19R-4/PC	4' (1219mm)	1250mm rod centres

- ask about banner rails for 3mm cable, 3mm and 10mm rod

## Hanging rails



### 25mm diameter hanging/banner rails

- ideal for light weight merchandise
- polished chrome rails, supplied with supports to fit directly onto 1.5mm cables/6mm rods, no additional fittings required
- shorter lengths cut to size



Item Code:	Length:	Cable centre:
HR25C-3/PC	3' (914mm)	944mm cable centre
HR25R-3/PC	3' (914mm)	944mm rod centres

# Product display



Acrylic cubes and boxes, with or without lids - a dynamic way to display products.

Flat shelves, sloping shelves, narrow shelves under posters, framed displays. Any way you want to display your products, we can help.



Ensure your products are displayed in the best possible way and they will sell themselves! Choose from a wide range of dynamic shelving and display options to maximise your sales.



# Shelving for use with cable/rod systems

## Drilled and slotted shelves - use with 1.5mm cables



- 6mm toughened safety glass

### 330mm depth

Item Code:	Shelf Size (mm):	Cable centre (mm):
<b>391330</b>	391w x 330d	For <b>A3</b> cable centres 331w x 300d
<b>514330</b>	514w x 330d	For <b>A2</b> cable centres 454w x 300d
<b>688330</b>	688w x 330d	For <b>A1</b> cable centres 628w x 300d

### 180mm depth

Item Code:	Shelf Size (mm):	Cable centre (mm):
<b>688180</b>	688w x 180d	For <b>A1</b> cable centres 628w x 150d



### Time saving tip

Use drilled and slotted shelves with CS01 (p22) – shelves can be removed for cleaning without using any tools

## Plain shelves - use with cable or rod systems

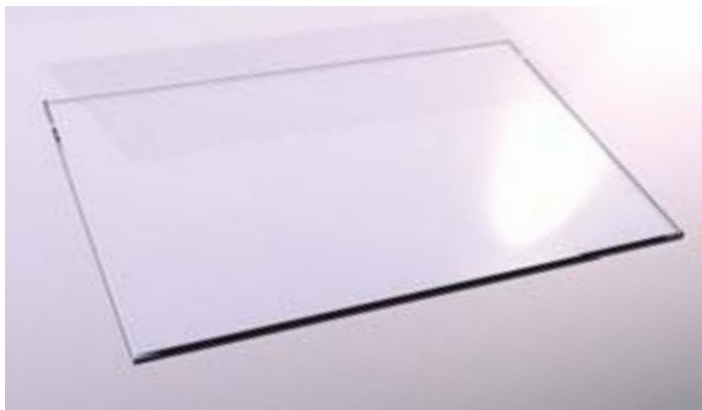

- 6mm toughened safety glass  
- for shelf supports see p22, 25, 32 and 36

### 330mm depth

Item Code:	Shelf Size (mm):	Cable centre (mm):
<b>618330</b>	618w x 330d	For <b>A1</b> cable centres 628w x 300d



## Special shapes & sizes available on request



Available in glass and acrylic

## Flat shelf with lip For use on wall-mounted rods

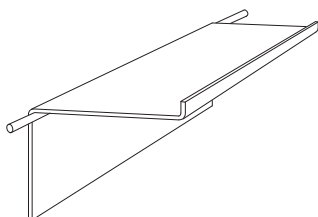

Use as a group to make a feature or use under an A2 pocket to create a powerful wall display with graphics and product.

- 2mm thick acrylic  
- shelf is 448mm wide x 120mm deep with a 10mm lip and a 100mm drop back

Item Code:	Size:
<b>HA2-93</b>	<b>A2</b>
For use with RS03	
<b>HA2-103</b>	<b>A2</b>
For use with WM11	

- fixing details see p43

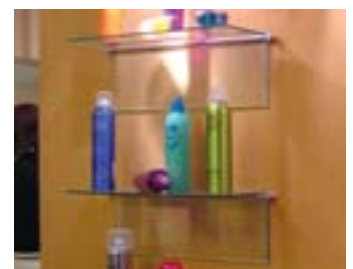

# Acrylic display cubes

## Standard cube kits

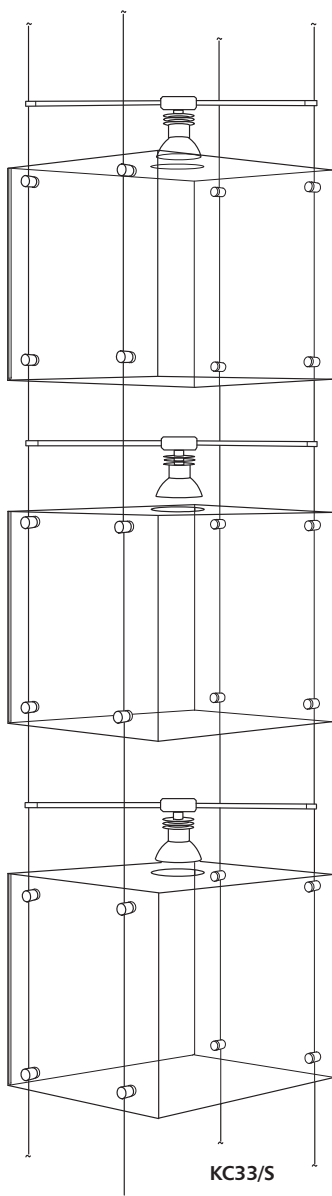

Acrylic cubes suspended from the cables create powerful semi-secure presentations. The low-voltage lighting greatly increases the impact of the display and will help to increase sales.

Dimensions: 300 h x 300 w x 250 d (150mm cable centres)

Cubes are in 3mm thick acrylic, with option of 2mm thick 'U' shaped back pocket for graphics. Clear front and satin side and top. Removable lid with hole for lighting.

### Included in standard cube kits

- 3 x Display Cubes
- 4 x CA4 1.5mm dia. Cables
- 24 x CS13-ADC Panel Support to take 3mm material
- 3 x LM64C Straight light mini-lamp head for 348mm diagonal centres supplied with 20 watt - 35mm dia. lamps
- 1 x LT60-12 Transformer
- 2 x CS08 Power Connectors
- 4 x PC01/1 Top Isolators
- 4 x SP/IS Bottom Isolators

Item Code:	Description:
KC33/S	Satin acrylic without pocket
KC33-P/S	Satin acrylic with pocket



Low voltage straight lights (20 watt max) are supplied with all our cube kits. Position them diagonally between cables

Cubes can be placed side by side sharing a pair of cables. Only use 3 lights per pair of diagonal cables



Cubes can be suspended on cables or rods. Ask about customised cube displays, including security features, integrated graphics and lighting



# Low voltage Display lighting



**Adding low voltage lighting to your cable or rod displays will increase visual impact and increase your sales by up to 107%**

- Quick and easy to install
- Light fittings are easy to specify - just follow our step-by-step guide on the next page
- All you need to complete the installation is an electrical spur, positioned within 2m of the transformer
- No need to use special cables - our lighting uses our standard cables or rods, retaining strength and load bearing capacity



**add  
visual  
impact**

**increase  
sales**

**high  
quality**

**easy to  
install**

## HOW MANY LIGHTS CAN I PUT ON ONE PAIR OF CABLES\*?

The answer to this lies in the type of light you have selected

Single lights are powered on a 12V system and require a 60W transformer (order code LT60-12)

This means on one pair of cables fitted with a 60W transformer you can have:

**1 x 50W light**

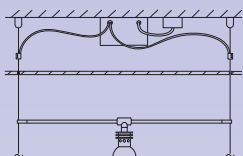

or

**Up to 3 x 20W lights**

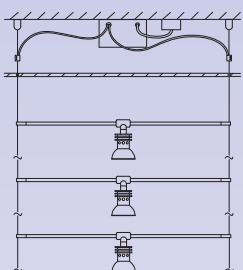

Double lights are powered on a 24V system and require a 100W transformer (order code LT100-24)

This means on one pair of cables fitted with a 100W transformer you can have:

**2 x 50W lights**

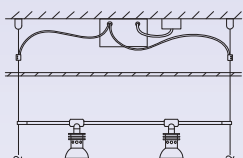

or

**Up to 4 x 20W lights**

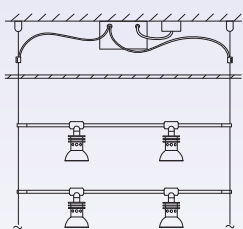

**\*Remember, only one transformer per pair of cables.**

For light configurations other than those above, please call.

# Choosing your lighting...

This guide will help you choose the right lights for your displays and ensure you select all the right component parts, giving you easy, problem-free installation.

When you know what your display is going to look like and consist of (display panels, shelves, leaflet holders), you can choose lights to maximise their impact. Just follow this easy step-by-step guide:

- 1** Check the panel on the left to see how many lights you can put on one pair of cables
- 2** Next choose the style of lights you'd like (see pages 53 to 56).
- 3** Remember to add the correct transformer, power connectors and isolators to your order (see page 59)
- 4** Choose which lamps you want - standard dichroic lamps (20 or 50 watt) are included in the price of the fitting. See page 59 for extra long life, extra bright or coloured lamps

**That's it! Place your order and look forward to boosting your sales with exciting displays!**



## How the lighting works:

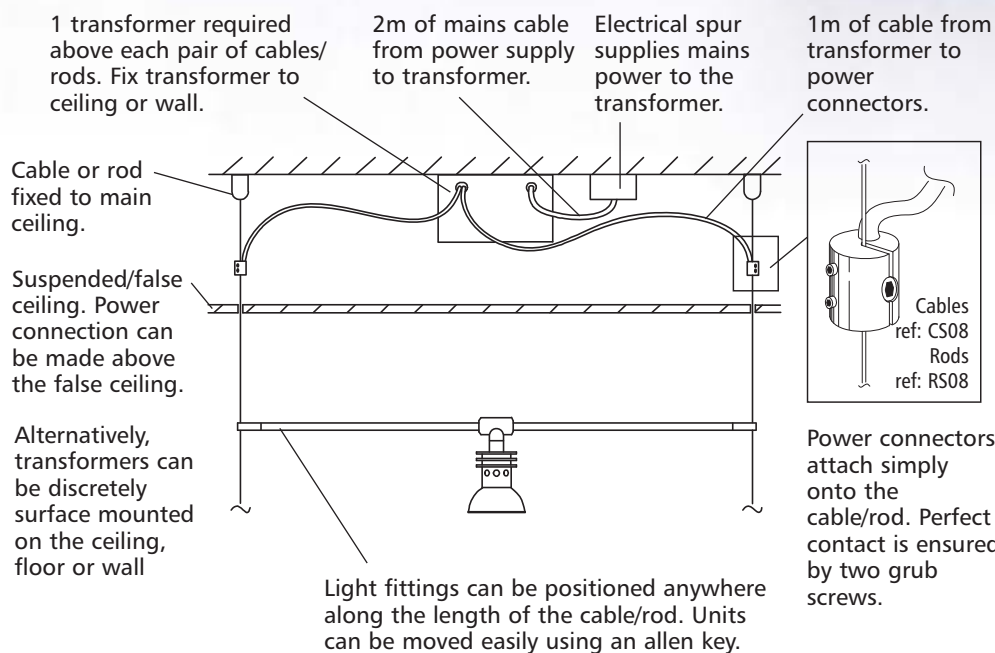

# Cantilevered lights

- ideal for lighting graphic panels or posters
- lights have 180° adjustable heads and project 150mm from cable/rods
- available in either single (50W) or double (2 x 50W) options
- use single lights for graphics up to A2
- double lights are available as special orders up to 1000mm wide - just ask for details and prices

## Single cantilevered lights - 1 x 50W lamp included



- requires transformer LT60-12
- 12 volt
- to fit A4, A3, A2 and up to 636mm cable/rod centres

### A4 To fit A4 cable/rod centre

Code:	Cable/rod size:
LA4SC/SI	To fit 1.5mm cable
LA4SC-3/SI	To fit 3mm cable/rod
LA4SR/SI	To fit 6mm rod



### A3 To fit A3 cable/rod centre

Code:	Cable/rod size:
LA3SC/SI	To fit 1.5mm cable
LA3SC-3/SI	To fit 3mm cable/rod
LA3SR/SI	To fit 6mm rod



### A2 To fit A2 cable/rod centre

Code:	Cable/rod size:
LA2SC/SI	To fit 1.5mm cable
LA2SC-3/SI	To fit 3mm cable/rod
LA2SR/SI	To fit 6mm rod

### + To fit cable/rod centre up to 636mm

Code:	Cable/rod size:
LM6SC/SI	To fit 1.5mm cable
LM6SC-3/SI	To fit 3mm cable/rod
LM6SR/SI	To fit 6mm rod

- specify size required



### NEW budget single cantilevered light 1 x 50W

- requires transformer LT60-12
- 12 volt
- to fit A4. Other sizes available on request

### A4 To fit A4 cable/rod centre

Code:	Cable/rod size:
LWA4SC	To fit 1.5mm cable
LWA4SC-3	To fit 3mm cable/rod

### To fit 466mm cable/rod centres

Code:	Cable/rod size:
LW466SC	To fit 1.5mm cable
LW466SC-3	To fit 3mm cable/rod

- for double A4 pocket M2A4PW (p41)

## Double cantilevered lights - 2 x 50W lamps included



- requires transformer LT100-24
- 24 volt
- to fit A4, A3, A2 and up to 636mm cable/rod centres

### A2 To fit A2 cable/rod centre

Code:	Cable/rod size:
LDA2SC/SI	To fit 1.5mm cable
LDA2SR/SI	To fit 6mm rod



### A1 To fit A1 cable/rod centre

Code:	Cable/rod size:
LDA1SC/SI	To fit 1.5mm cable
LDA1SR/SI	To fit 6mm rod

### + To fit cable/rod centre up to 636mm

Code:	Cable/rod size:
LDM6SC/SI	To fit 1.5mm cable
LDM6SR/SI	To fit 6mm rod

- specify size required

# Customised cantilevered lights

## Double sided cantilevered lights - lamps included

Single



### Single double sided cantilevered lights - 2 x 20W

- requires transformer LT60-12
- 12 volt
- to fit any size from A4 up to 636mm cable/rod centres - please specify size when ordering

#### 1 x 20W single light on each side

Code:	Cable/rod size:
L2M6SC/SI	To fit 1.5mm cable
L2M6SR/SI	To fit 6mm rod

### Twin double sided cantilevered lights - 4 x 20W

- requires transformer LT100-24
- 24 volt
- to fit any size from A2 up to 840mm cable/rod centres - please specify size when ordering

#### 2 x 20W single lights on each side

Code:	Cable/rod size:
L2DM8SC/SI	To fit 1.5mm cable
L2DM8SR/SI	To fit 6mm rod

## Extra wide cantilevered lights - lamps included

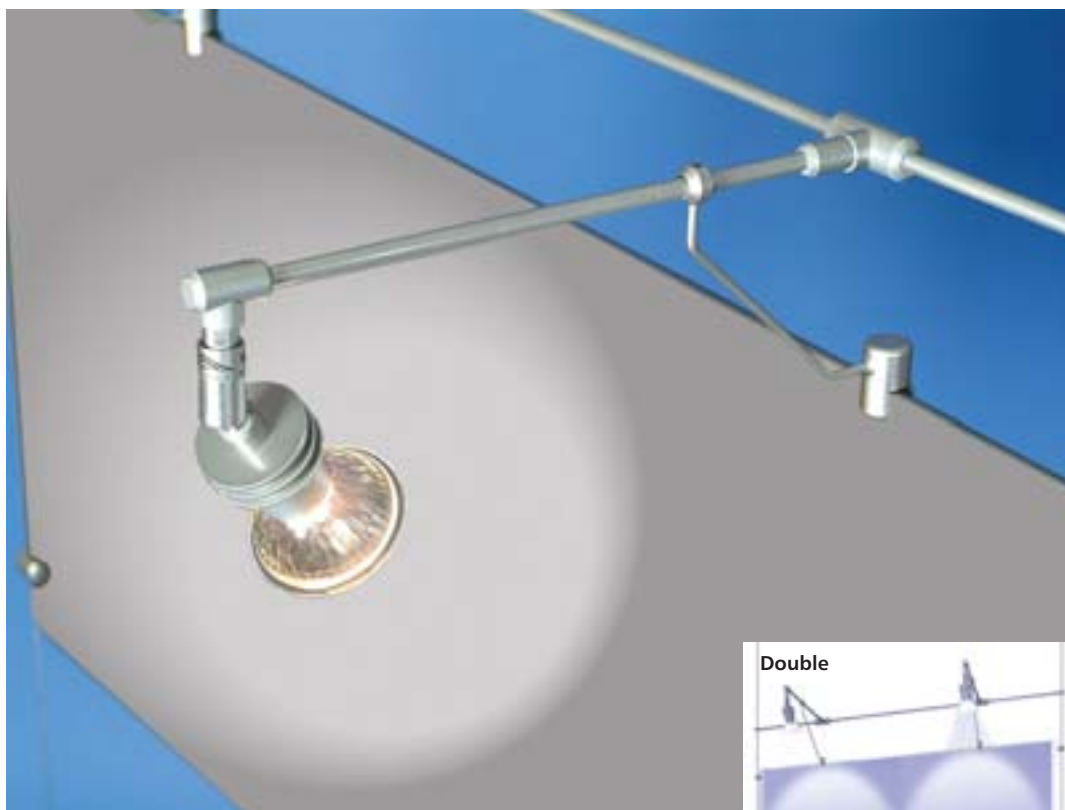

- light projects 200mm
- to be used on panels up to 7mm thick
- to fit up to 1000mm cable/rod centres - please specify size when ordering

### Single - 1 x 50W

- requires transformer LT60-12
- 12 volt

#### To fit cable/rod centres up to 600mm

Code:	Cable/rod size:
LM6PC/SI	To fit 1.5mm cable
LM6PR/SI	To fit 6mm rod

### Double - 2 x 50W

- requires transformer LT100-24
- 24 volt

#### To fit cable/rod centres up to 1000mm

Code:	Cable/rod size:
LDM8PC/SI	To fit 1.5mm cable
LDM8PR/SI	To fit 6mm rod

# Straight lights

- ideal for lighting shelving presentations
- straight fitting - lamp is positioned in the middle or offset with 180° adjustment
- available in either single (1 x 20W) or double (2 x 50W) options

## Single straight lights - 1 x 20W lamp included



Single straight light

- fits side cable/rod with cable/rod centres of 300mm
- requires transformer LT60-12
- 12 volt



### To fit 300mm cable/rod centre

Code:	Cable/rod size:
LM3C/SI	To fit 1.5mm cable
LM3R/SI	To fit 6mm rod

## Double straight lights - 2 x 50W lamps included



- Set of 2 lights for use on the front of shelving
- requires transformer LT100-24
- 24 volt

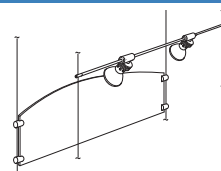

### A2 To fit A2 cable/rod centre

Code:	Cable/rod size:
LDA2C/SI	To fit 1.5mm cable
LDA2R/SI	To fit 6mm rod

### A1 To fit A1 cable/rod centre

Code:	Cable/rod size:
LDA1C/SI	To fit 1.5mm cable
LDA1R/SI	To fit 6mm rod

### + To fit cable/ rod centre up to 636mm

Code:	Cable/rod size:
LDM6C/SI	To fit 1.5mm cable
LDM6R/SI	To fit 6mm rod

- specify size required

## Single straight lights with swivel feature - 1 x 20W lamp included

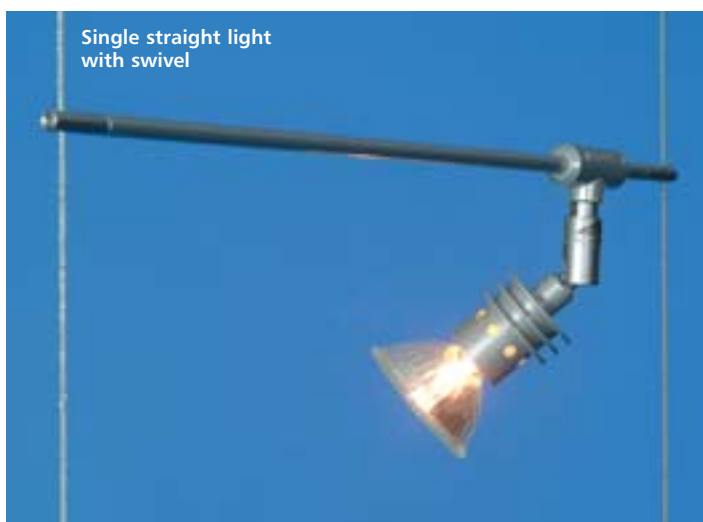

Single straight light with swivel

- fits side cable with cable centres of 300mm
- requires transformer LT60-12
- 12 volt

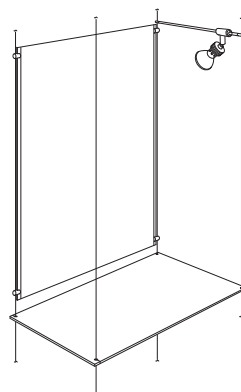

### To fit 300mm cable centre

Code:	Cable size:
LM30CS/SI	To fit 1.5mm cable

# Wirelights

- Wirelights are an elegant yet cost-effective way to illuminate any display supported on cables or rods
- lamps are angled down to give a good overall spread of light
- available in either single (1 x 50W) or double (2 x 50W) options
- cool-to-the-touch black silicone rings are also included for extra elegance

## Single Wirelights - 1 x 50W lamp included



### Single Wirelight - 50W

- lamps project 150mm from cables
- requires transformer LT60-12
- 12 volt

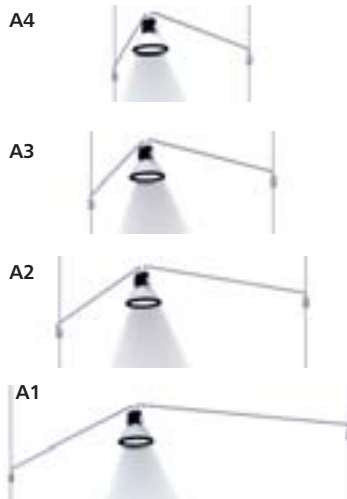

#### A4 to fit A4 cable/rod centre

Code:	Cable/rod size:
LWA4C	To fit 1.5mm cable
LWA4C-3	To fit 3mm cable/rod
LWA4R	To fit 6mm rod

#### A3 to fit A3 cable/rod centre

Code:	Cable/rod size:
LWA3C	To fit 1.5mm cable
LWA3C-3	To fit 3mm cable/rod
LWA3R	To fit 6mm rod

#### A2 to fit A2 cable/rod centre

Code:	Cable/rod size:
LWA2C	To fit 1.5mm cable
LWA2C-3	To fit 3mm cable/rod
LWA2R	To fit 6mm rod

#### A1 to fit A1 cable/rod centre

Code:	Cable/rod size:
LWA1C	To fit 1.5mm cable
LWA1C-3	To fit 3mm cable/rod
LWA1R	To fit 6mm rod



### NEW budget single cantilevered light 1 x 50W

- requires transformer LT60-12
- 12 volt
- to fit A4. Other sizes available on request

#### A4 To fit A4 cable/ rod centre

Code:	Cable/rod size:
LWA4SC	To fit 1.5mm cable
LWA4SC-3	To fit 3mm cable/rod

#### To fit 466mm cable/rod centres

Code:	Cable/rod size:
LW466SC	To fit 1.5mm cable
LW466SC-3	To fit 3mm cable/rod

- for double A4 pocket M2A4PW (p41)

## Double sided Wirelights - 2 x 50W lamps included

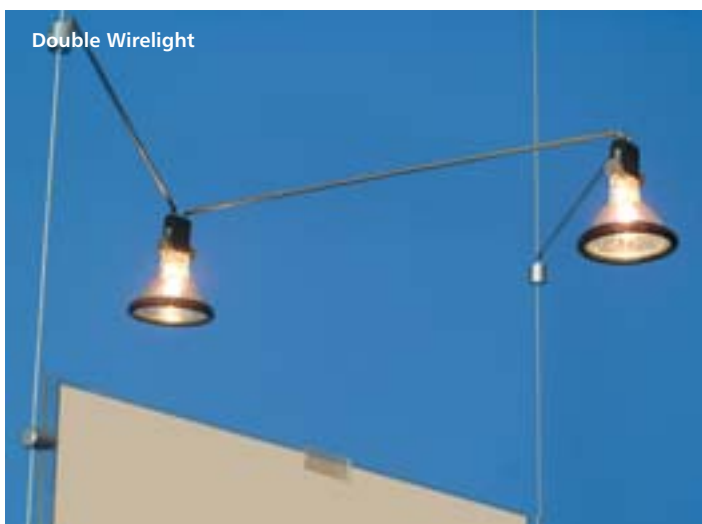

### Double-sided Wirelight - 2 x 50W

- lamps project 150mm from cables
- requires transformer LT100-24
- 24 volt



#### A4 to fit A4 cable/rod centre

Code:	Cable/rod size:
LDWA4C	To fit 1.5mm cable
LDWA4R	To fit 6mm rod

#### A3 to fit A3 cable/rod centre

Code:	Cable/rod size:
LDWA3C	To fit 1.5mm cable
LDWA3R	To fit 6mm rod

#### A2 to fit A2 cable/rod centre

Code:	Cable/rod size:
LDWA2C	To fit 1.5mm cable
LDWA2R	To fit 6mm rod

#### A1 to fit A1 cable/rod centre

Code:	Cable/rod size:
LDWA1C	To fit 1.5mm cable
LDWA1R	To fit 6mm rod

Please note: screw must be retightened after lamp replacement

# Hightrack kits



Hightrack is a low-voltage system using an ultra-slim track profile and miniature spotlights. It provides ultimate flexibility and freedom in lighting design.

- distinctive low-voltage fittings make this system ideal for retail, display, exhibitions, galleries, offices and leisure applications
- quick and easy way to order track lighting
- select the length of track required and the number of spots and you will be supplied with everything you need, including lamps and transformer
- shown here are some of our most popular kits. For more, please ask for details



KHT6



SP Head



H2 Head



SP Head with Steel cover

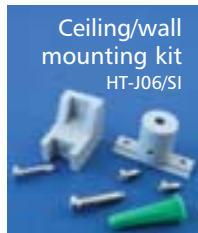

Ceiling/wall mounting kit  
HT-J06/SI

Code: Description

Lamp fittings

### Ceiling/wall mounted track kits

KHT1	1 metre track with 3 x 35 watt IRC lamps, inline transformer (105va) with 2m mains cable and 3-pin plug (for wall mounting order HT-J01/SI)	SP Heads
KHT2	As above	H2 Heads
KHT6	1.5 metre track with 4 x 35 watt IRC lamps, inline transformer (150 va) with 2m mains cable and 3-pin plug (for wall mounting order HT-J01/SI)	SP Heads
KHT7	As above	SP Heads with Steel Cover
KHT8	As above	H2 Heads
KHT9	As above	H2 Heads with 200mm pendant
KHT15	1.5 metre track with 4 x 50 watt lamps, remote electronic transformer (200 va) with 2m low voltage cable, 2m mains cable and 3-pin plug (for wall mounting order HT-J01/SI)	SP Heads
KHT16	As above	SP Heads with Steel Cover
KHT17	As above	H2 Head
KHT18	As above	H2 Heads with 200mm pendant
KHT25	3 metre track with 6 x 50 watt lamps, round toroidal transformer (300 va) with 2m mains cable and 3pin plug (for wall mounting order HT-J01/SI)	SP Heads
KHT26	As above	H2 Heads
KHT27	As above	H2 Heads with 200mm pendant

### Mounting Kits

- HT-J06/SI Ceiling/wall mounting kit - silver (fix every 500mm)  
HT-J05/SI Cable suspension kit



H2 Head with 200mm pendant



Cable suspension kit  
HT-J05/SI

# Highlight

Transform the appearance of your display units, exhibition stand or window display with a touch of sparkle - people are drawn by bright light, thus increasing the impact of presentations and sales messages

- miniature low-voltage fittings which will take up to 50 watt lamps (not included)
- transformers LT50-12 or LT100-E

## Mono lights



- miniature low-voltage spotlight

### Mono light

Code:  
H2/A/SI

## Transformers



LT50-12  
50VA

### Transformer

Code:  
LT50-12  
LT100/E  
LT200/E

For full specifications please see [www.fairfielddisplays.co.uk](http://www.fairfielddisplays.co.uk)



LT100/E  
Electronic 100VA



LT200/E  
Electronic 200VA

## Mono pendant lights



Pendant

- miniature low-voltage spotlights with a choice of pendant length
- pendant created from 6mm tube
- angle adaptor option allows lamp head to swivel an additional 90° in order to shine onto the ceiling or wall
- flexible stem option allows lamp to be adjusted to any position



Pendant with angle adaptor



Flexible stem

### Pendants

Code:	Tube length:
H2/E2/SI	200mm
H2/E3/SI	300mm
H2/E5/SI	500mm

### Pendant with angle adaptor

Code:	Tube length:
H2/E2A/SI	200mm
H2/E3A/SI	300mm

### Flexible stem

Code:	Tube length:
H2/F2/SI	200mm
H2/F3/SI	300mm
H2/F5/SI	500mm

## Duo lights



100mm lamp centres



100mm lamp centres with swivel

- ideal for concentrated light
- excellent feature light for enhancing both products and graphic displays
- choice of pendant length

### Duo straight

Code:	Tube length:
100mm lamp centres:	
H2/E2D1/SI	200mm
H2/E5D1/SI	500mm
425mm lamp centres:	
H2/E2D4/SI	200mm
H2/E5D4/SI	500mm

### Duo with swivel

Code:	Tube length:
100mm lamp centres:	
H2/E2D1S/SI	200mm
H2/E5D1S/SI	500mm
425mm lamp centres:	
H2/E2D4S/SI	200mm
H2/E5D4S/SI	500mm

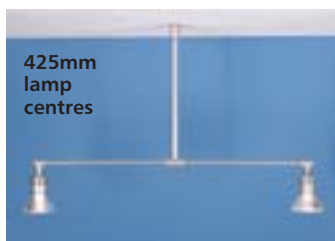

425mm lamp centres



425mm lamp centres with swivel

# Lighting accessories

## Transformers - see page 52 for number of lights per transformer



### LT60-12 12v transformer

152 x 88 x 120mm. Weight 2.18kg

### LT100-24 24v transformer

152 x 88 x 120mm. Weight 2.3kg

#### LT60-12

Code: LT60-12

#### LT100-24

Code: LT100-24

- supplied with 2m input lead and 1m output lead

- includes protection against overheating, overloading and short-circuits

**- remember to order power connectors (see below)**

## Lamps - 50mm diameter



### Standard dichroic lamps

- top quality, glass fronted lamp with an average lamp life of 5,000 hours

#### 20W lamp

Code: LD20/W Beam angle: 36°

#### 50W lamp

Code: LD50/24 Beam angle: 24°

### Extra long life lamps

- average lamp life 10,000 hours  
- more than a years life based on 24 hours a day usage  
- saves time and money, reduces the hassle of changing lamps

#### 50W lamp

Code: LD50-UL/24 Beam angle: 24°

### IRC lamps - 70% brighter

- average lamp life 4,000 hours  
- brightness equivalent to a 65W dichroic lamp

#### 50W lamp

Code: LD50-IR/24 Beam angle: 24°

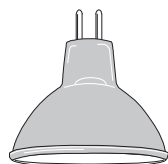

Silver

### Silver lamps

Add a touch of style - change the appearance of your lamp fittings - the external casing of the lamp is silver.

- light projects forward only  
- average lamp life 3,500 hours

#### 20W lamp

Code: LD20/S Colour: Silver Beam angle: 36°

#### 50W lamp

Code: LD50/S Colour: Silver Beam angle: 36°

## Silicone rings



Add a touch of style - gives the finishing touch to any 50mm diameter lamp. The black Silicone ring just clips onto the rim of the lamp.

#### Silicone ring

Code: LHR/BL



## Power connectors and isolators



### Power connectors

- allows electrical power to be connected to the cable or rod  
- perfect contact is ensured by two grub screws  
- Satin chrome finish

#### Power connector

Code: CS08 For 1.5mm cable  
CS08-3 For 3mm cable or rod  
RS08 For 6mm rod



Add isolators when using channel or installing into metal ceilings or floors

### Top isolator

- Black nylon for cables, white nylon for rods

#### Top isolator

Code: PC01/I For cables  
PR01/I For rods



Top Isolator

### Bottom isolator

- in 3 nylon sections

#### Bottom isolator

Code: SP/IS For cables & rods

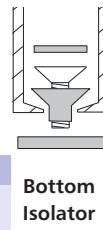

Bottom Isolator

### In-line rod isolator

- insert when metal accessories touch both rods to avoid fusing

#### Inline isolator

Code: LIJ For 6mm rods



Ask about the extensive range of freestanding displays



Providing instant 3D walk-round access, freestanding displays make standing out in the crowd so easy.

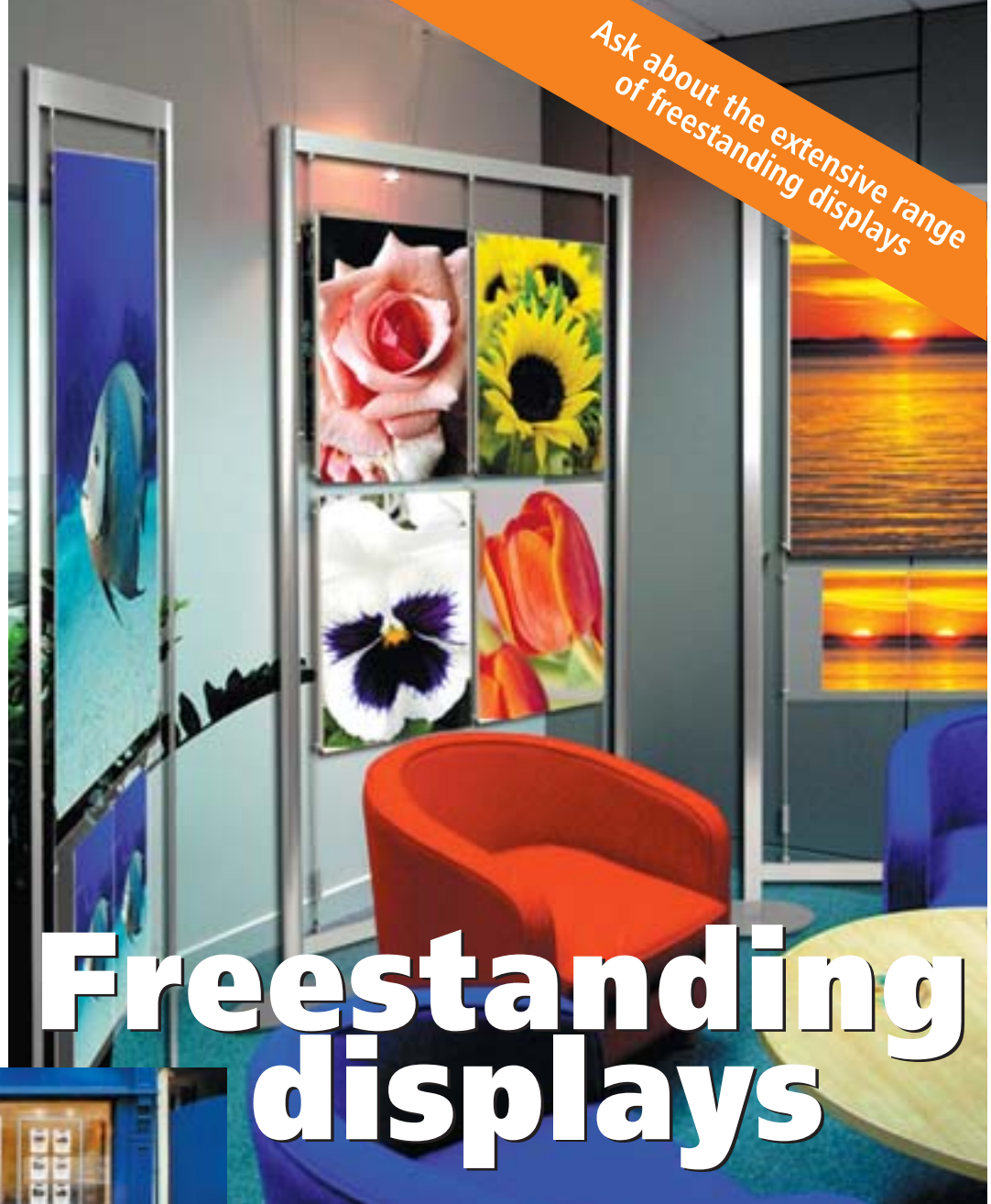

# Freestanding displays



Make the most of your floor space by promoting your image, products and services to best effect using our range of freestanding display units.



Make an impact with your information. Use pockets and frames for maximum style...and maximum sales.



# Freestanding units

## Single Freestyle frame - flat profile upright



Available in 3 widths - 990mm, 1230mm and 1730mm

Freestyle frames are lightweight satin silver aluminium units ideal for use on exhibition stands, conferences and reception areas

- combine posters, leaflet dispensers, sloping shelves - create a display that gets your message across!
- all units 1900mm high
- steel bases are 330mm diameter
- supplied flat packed. Can be supplied assembled on request

Item Code:	External width including base mm:	Internal width mm:
KFL-759	1134	759
KFL-1000	1375	1000
KFL-1500	1875	1500

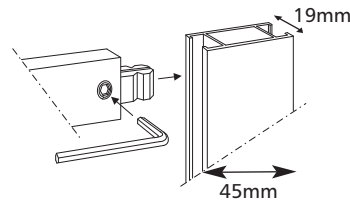

Flat uprights - single frame



### Freestyle frame kit

- comprises KFL-759 Freestyle frame, 1 x A1 portrait acrylic pocket, 2 x quick fit cables and 4 x CG03 panel clamps

Item Code:	Description:
KFL-759-A1	1 x A1 Kit

## Single Freestyle frame - round profile upright



Available in 3 widths - 990mm, 1230mm and 1730mm

Satin silver aluminium units with 50mm diameter uprights and flat horizontal profiles

- combine posters, leaflet dispensers, sloping shelves - create a display that gets your message across!
- all units 1980mm high
- steel bases are 330mm diameter
- supplied flat packed. Can be supplied assembled on request

Item Code:	External width including base mm:	Internal width mm:
KFR-759	1134	759
KFR-1000	1375	1000
KFR-1500	1875	1500

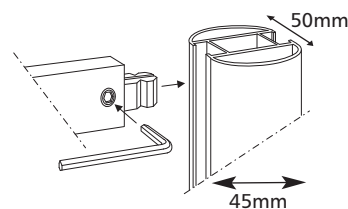

Round uprights - single frame



### Freestyle frame kit

- comprises KFR-759 Freestyle frame, 8 x A4 portrait acrylic pockets, 4 x quick fit cables and 32 x CG03 panel clamps

Item Code:	Description:
KFR-759-8A4	8 x A4 Kit

## Flexi-frames - double and treble

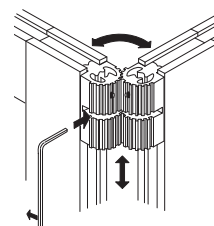

Flexible hinge allows unit to fold flat for easy storage and transporting

Lightweight satin silver aluminium units ideal for use on exhibition stands, conferences, reception areas or in-store

- Double and treble frames with flexible hinges
- flat profile measures 45mm x 19mm deep
- all units 1900mm high
- supplied flat packed. Can be supplied assembled on request
- special sizes on request

Item Code:	Description:	External width mm:	Internal width mm:
AF2	<b>Double</b>	2 x 850 width frames	759
AF3	<b>Treble</b>	3 x 850 width frames	759

# Frame accessories

## Brackets



Doubled sided bracket



### Double sided bracket - supports cables/rods (not included)

- two sizes available:

150mm cable/rod centres, ideal for small shelves, sloping shelves and acrylic cubes

300mm cable/rod centres, ideal for shelving and double depth displays

### Single sided bracket - supports cables/rods in front of frame

- projects 50mm

- can also be used to support cables away from the wall on exhibition stands (fits wall depth 20mm). Order cables/rods separately

Item Code:	Description:	Cable/rod centres mm:
KMFB1/SI	Single sided bracket	-
KMFB3/SI	Double sided bracket	300
KMFB15/SI	Double sided bracket	150

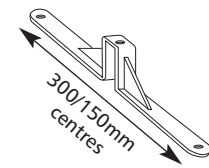

Double sided bracket

Brackets fit a profile up to 20mm deep

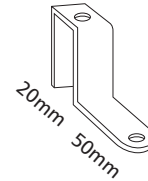

Single sided bracket

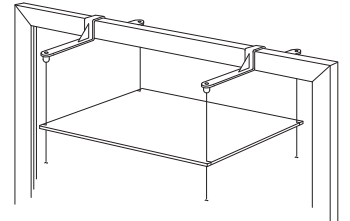
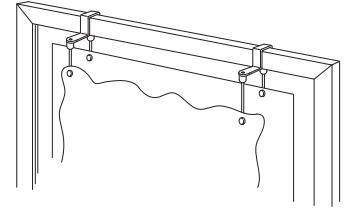

Use brackets to support a wide range of accessories - shelves, panels, leaflet dispensers...

See Product and Graphic Display sections (p40-50) for accessories to use with frames

## Other accessories

### Quick fit cable

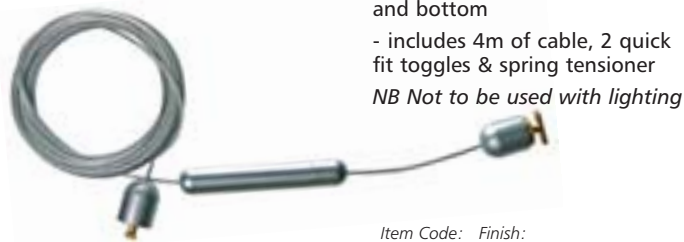

- cable designed to be used with freestanding frames top and bottom

- includes 4m of cable, 2 quick fit toggles & spring tensioner  
*NB Not to be used with lighting*

Item Code:	Finish:
<b>CQQ</b>	<b>Satin Chrome</b>



### Toggle

- for fixing standard cable or rod to freestanding frames

- can be used with all top and bottom cable/rod fittings

- allen key provided



Item Code:	Finish:
<b>AT</b>	<b>Silver</b>

### Fitting to fix channel to wall

- for fixing channel to wall  
- available in spacers size 12.5mm, 25mm and 50mm from wall

Item Code:	Space from wall:
KWC-1	12.5mm
KWC-3	25mm
KWC-2	50mm
with adjustable screw thread for uneven walls with flange	
KWC-4	50mm
with adjustable screw thread for uneven walls	

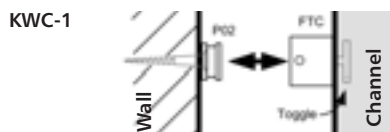

Right angle channel for wall fixing

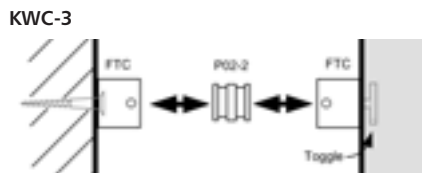

KWC-2 and KWC-4 with adjustable screw thread for uneven walls

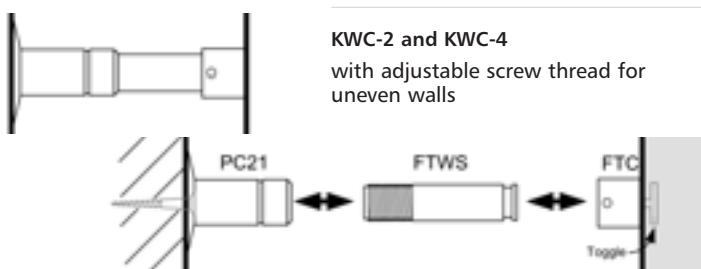

KWC-2 with flange

KWC-4 without flange

# Freestanding units

## Info-post



Create an instant presentation to display signs, posters and leaflets.

Perfect for use in:

- reception areas for company information or as a directory sign
- shop windows
- near a sales counter or customer service desk
- on exhibition stands

### Info-post kits

Kits are supplied complete with:

- a 1980mm satin aluminium upright
- 330mm diameter base unit
- set of 6 A4 portrait acrylic pockets, either hook-on pockets with rods or side supported easy access pockets
- all fittings supplied
- kits are supplied flat packed and can be assembled in minutes

Item Code: Description:

KIPA-6A4 **Kit with side supported pockets**  
KIPA-H6A4 **Kit with hook-on pockets**

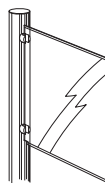

KIPA-6A4  
Info-post with side supported pockets

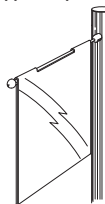

KIPA-H6A4  
Info-post with hook-on pockets

### Upright and base only

- 1980mm satin aluminium upright with 330mm diameter silver painted base

Item Code: Description:

IPA20 **Upright and base**

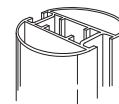

IPA20

### Supports

Choose from:

- satin chrome clamp to take panels up to 10mm thick or
- horizontal stainless steel rods, supplied with quick fit toggle that allows easy relocation. Comes with REC decorative end fitting in satin chrome. Available in 2 sizes to take A4 portrait or A4 landscape

Item Code: Description:

KPC **Clamp for panels up to 10mm**  
KR230 **Rod to take A4 portrait**  
KR317 **Rod to take A4 landscape**

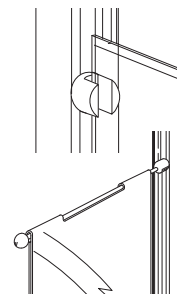

### Pockets

- 3mm thick high impact acrylic for increased durability in public areas
- supplied with wing on the left or right hand side
- use with KPC support clamps

Item Code: Description/size: Left or right fixing:

MA5PW/LH	<b>A5 Portrait</b>	Left
MA5PW/RH	<b>A5 Portrait</b>	Right
MA5LW/LH	<b>A5 Landscape</b>	Left
MA5LW/RH	<b>A5 Landscape</b>	Right
MA4PW/LH	<b>A4 Portrait</b>	Left
MA4PW/RH	<b>A4 Portrait</b>	Right
MA4LW/LH	<b>A4 Landscape</b>	Left
MA4LW/RH	<b>A4 Landscape</b>	Right

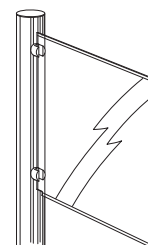

KIPA-H6A4  
Info-post kit  
supplied with  
6 A4 hook-on  
pockets

KIPA-6A4  
Info-post kit  
supplied with  
6 A4 side  
supported  
pockets

Info-Post with  
A4 leaflet  
dispenser

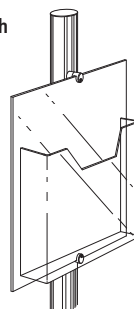

Info-Post with  
double A4  
pockets

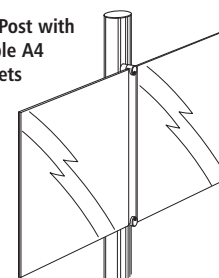

## The eye is drawn to light...

An illuminated poster or graphic can increase sales by up to an incredible 107% over a non-illuminated presentation.



# Light boxes

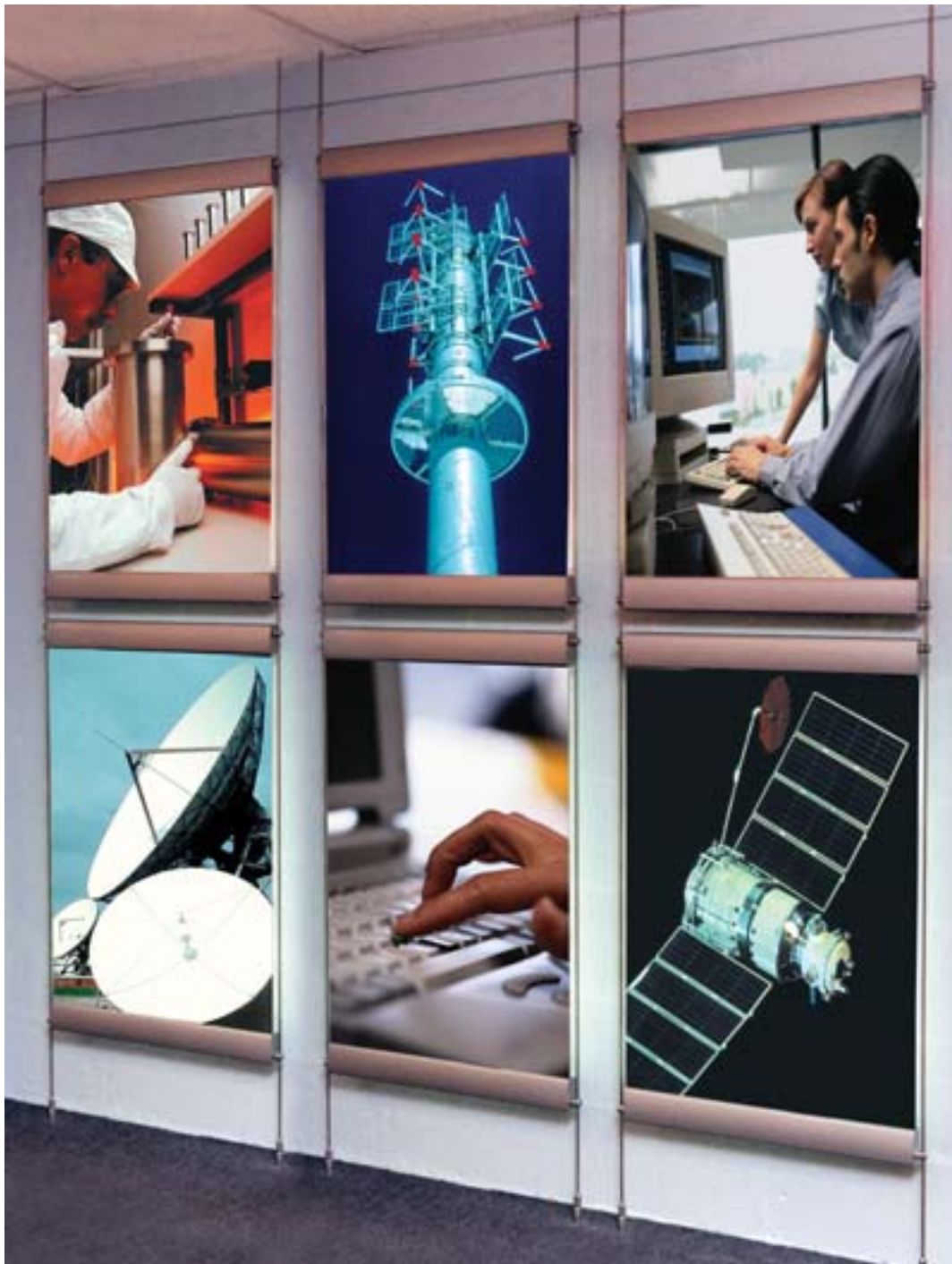

Using the latest technology coupled with an incredibly long lamp life, our wall mounted or suspended light boxes give you maximum impact in your premises.



# Light boxes - single & double sided

## Cold cathode light boxes

- cold cathode light boxes use the very latest light technology, making them incredibly bright and light weight.
- extremely long lamp life - up to 50,000 hours (approx. 5 years)
- lux level at panel centre of A1 unit is 1092 lux, making it one of the brightest around
- supplied with a 3-pin plug
- stylish, slim click frame, 30mm wide x 35mm deep
- available in sizes A4 - A0
- use wall mounted or suspended on cable/rod system
- use portrait or landscape

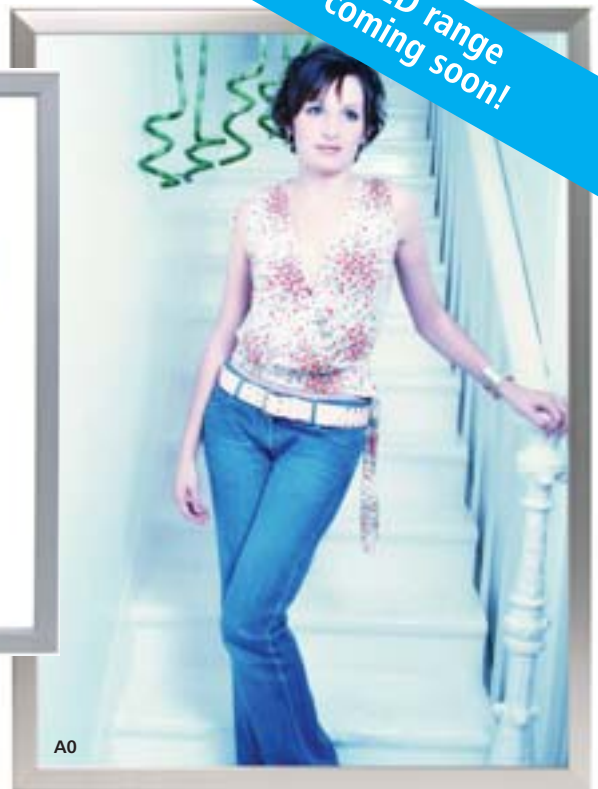
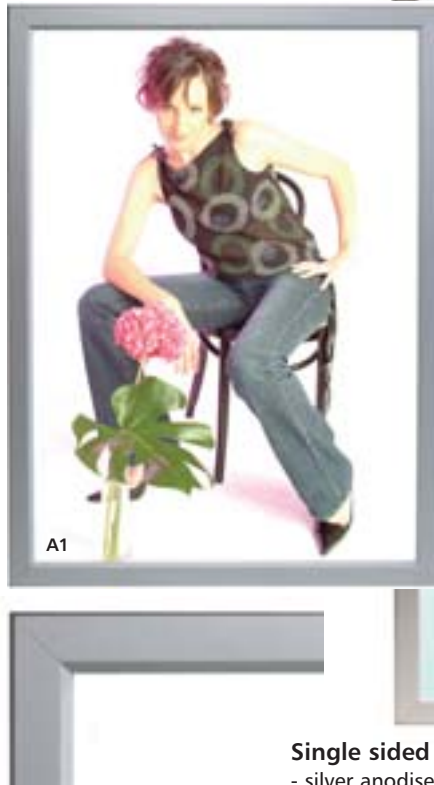

LED range coming soon!

### Single sided light boxes

- silver anodised finish

Item Code:	Size:	Frame size	Viewing area	Max graphic area
LBA4-CC	A4	257 x 334	197 x 284	215 x 302
LBA3-CC	A3	342 x 464	282 x 404	299 x 421
LBA2-CC	A2	467 x 641	407 x 581	435 x 599
LBA1-CC	A1	641 x 886	581 x 828	599 x 845
LBA0-CC	A0	886 x 1235	828 x 1175	845 x 1193

All sizes given in mm and width x height

### Double sided light boxes

- double sided units can be suspended from cable/rod systems - ask for details

- brushed aluminium finish

Item Code:	Size:	Frame size	Viewing area	Max graphic area
LBDA2-CC	A2	467 x 641	407 x 581	435 x 599
LBDA1-CC	A1	641 x 886	581 x 828	599 x 845

All sizes given in mm and width x height



## Curved light boxes - wall mounted



- 25mm snap-on profile on 2 sides
- quick and easy to replace poster - no tools required
- protective, non-reflective PVC cover holds poster in position
- designed to enhance both Duratrans and posters
- silver anodised finish
- supplied with 2 metres of mains cable with 3 pin plug
- units are illuminated using standard fluorescent tubes
- portrait only

Item Code:	Size:	Poster dimensions	External measurements	Visible area
LBCA3	A3	297 x 420	320 x 425 x 80	275 x 420
LBCA2	A2	420 x 594	435 x 605 x 95	389 x 594
LBCA1	A1	594 x 841	610 x 855 x 115	572 x 841
LBCA0	A0	841 x 1189	850 x 1205 x 145	819 x 1189
LBCB2	B2	500 x 700	5150 x 705 x 105	478 x 700
LBCB1	B1	700 x 1000	705 x 1005 x 125	678 x 1000
LBC2030	20" x 30"	508 x 762	520 x 765 x 105	486 x 762
LBC3040	30" x 40"	762 x 1016	765 x 1020 x 135	740 x 1016

All sizes given in mm unless shown otherwise

To see the full product range visit the website or ring now for immediate information.

PAPER SIZE CHECK: A5 = 148 x 210mm A4 = 210 x 297mm A3 = 297 x 420mm A2 = 420 x 594mm A1 = 594 x 841mm A0 = 841 x 1188mm

# Light boxes - suspended

- Completely even spread of light which eliminates shadows
- Takes inkjet prints, duratans or standard paper up to 135gsm

- Graphics can be changed in seconds
- Extremely slim floating light boxes, single or double sided
- Invisible power supply, no ugly power cables

## Cold cathode light boxes



Compact cold cathode light box with a silver plastic frame suspended on rods with a low-voltage 12 volt power supply. Uses the very latest light technology.

Units can be used as headers with acrylic pockets underneath, as a set of 3 units to create a really powerful illuminated display or with the digital screen as part of a high technology presentation.

- size A3 - can be used portrait or landscape
- cold cathode tube incredibly bright - approximately 2000 lux levels
- units are incredibly light weight
- graphics can be changed in seconds
- profile size 40mm width x 25mm depth

See Digital Display page 72 for full details and components required for installation.



Item Code:	Size:
DCA3-DC	<b>A3 single sided, landscape/portrait</b> supplied with PO2 supports
DCDA3-DC	<b>A3 double sided, landscape/portrait</b> supplied with PO2 supports
DCA2-DC	<b>A2 single sided, landscape/portrait</b>

\* See website for current prices and latest products

## XtraLite



Use XtraLite in windows and interiors. Ideal for exhibition stands, reception areas and information centres.

### Standard XtraLite:

- T5 tubes. Aperture lamps with an average lamp life of 9,000 hours
- supplied with cables or rods, transformer, power connectors and isolators

Item Code:	Size:	Fixing
KXLA1C/SI	<b>A1</b>	Cables: 4m floor/ceiling
KXLA1R/SI	<b>A1</b>	Rods: 3m floor/ceiling

### LED Xtralite:

Best Value – Eco friendly and low maintenance costs

- Up to 100,000 hrs LED life (i.e. 10 years maintenance free)
- (Standard tubes with 9,000 hrs life would have to be changed 20 times – save on tube costs and labour costs)
- Top/Bottom clip frame for rapid poster change
- Eco friendly
- Up to 80% less power consumption compared to traditional florescent tubes
- Cool to touch
- 40 watt DC power supply

**Up to  
100,000 hrs  
LED Life**

### NEW!!

- supplied with cable or rods, power connectors and isolators

Item Code:	Size:	Fixing
KXLA1LEDC	<b>A1</b>	Cables: 4m floor/ceiling
KXLA1LEDR	<b>A1</b>	Rods: 3m floor/ceiling



- sales can be increased by up to **317%** when you install a moving display

- give your customers twice the information in one display - keep their interest for longer

- ideal for estate agents, window displays and information centres



# Moving displays

...movement increases sales!



# Moving displays

## E-motion



E-motion is available with a choice of 3 types of blades: pocket blades to take A4 information; poster blades to take 2 cut posters back to back; product panels with 100mm deep shelves for displaying items.

- delay from 3 to 20 seconds
- period of delay can be easily adjusted
- installation must be carried out by a qualified installer

- units supplied with power connectors, transformer, top/bottom cable/rod fittings and supports. The cable units are supplied with 4m cables, the rod units with 3m rods. Longer lengths can be supplied on request

New high level service on all E-motion units – onsite maintenance (UK only) and full guarantee of parts for 12 months after invoice date. Three year maintenance contract available – details on request



### Pocket blades

- large acrylic clear panels supplied with double sided A4 pockets
- information is easy to change
- panel width 215mm
- 4 pockets per blade
- overall height 1500mm
- 16 pocket unit 988mm cable/rod centres
- 20 pocket unit 1210mm cable/rod centres

For 1.5mm cables:

Item Code: Size:  
KEMA4/44C 16 x A4 pockets  
KEMA4/45C 20 x A4 pockets

For 6mm rods:

Item Code: Size:  
KEMA4/44R 16 x A4 pockets  
KEMA4/45R 20 x A4 pockets



### Poster blades

- takes 2 cut posters back to back, giving a double image
- available in A1 and A0 sizes
- 6 blades per unit



**A1:**

- overall height 1040mm
- poster strip size 840mm x 100mm
- 760mm cable/rod centres

**A1**  
Item Code: For cables/rods  
KEMA1/C For 1.5mm cable  
KEMA1/R For 6mm rod

**A0:**

- overall height 1400mm
- poster strip size 1200mm x 140mm
- 1000mm cable/rod centres

**A0**  
Item Code: For cables/rods  
KEMA0/C For 1.5mm cable  
KEMA0/R For 6mm rod



## Enhance your merchandise and sales message with customised units



Maximum size 1500mm wide x 1500mm high

Phones



Increase the impact of any display by adding sound and moving images! Research shows sales can increase by up to 317% (source POPAI).



# Digital displays

## Incorporate movement into your displays and watch sales soar!



New Digital Display System is highly compact and economical, which means small as well as large companies can benefit from the advantages of digital media.

*Digital Displays are the solution if you want to:*

- Present jpeg images, mpeg video and sound
- Increase awareness that will increase sales
- Update your display instantly without expensive print costs
- Grab the attention of passers-by with strong sales messages

*Where can Digital Display be used?*

- Shop windows
- Exhibition stands
- Showrooms
- Museums
- Offices
- Banks
- Point of Sale
- Airports

*Incredibly easy to use*

- Ultra slim - only 53 mm in depth
- Uses compact flash card media which can be changed in seconds
- Extra bright - can be viewed from any angle

# Digital displays - kits

## Digital screen

- all kits are supplied with a demo compact flash card and instruction manual
- depth 53mm, 17" wide screen

## Cold cathode light box

- only 25mm deep
- single and double sided options
- poster size 420mm x 297mm
- incredibly bright approx 2,000 lux levels

Kits are supplied with 6mm rods with a 3m drop, transformer and power connectors. Width of display 544mm. Installation must be carried out by a qualified installer.

Units are supplied with a range of guarantees - select the level of service that meets your requirements.

## Single cold cathode light box kits



- single sided or double sided light box kits
- supplied with 6mm rods and transformer

Item Code: Description:

KDCA3R-DC Single sided  
KDCA3R-D-DC Double sided

## Combined digital screen/light box kit



- kit comprising one single sided digital screen plus one single or double sided light box
- supplied with 6mm rods and transformer

Code: Description:

KD1-DC With single sided light box  
KD1-D-DC With double sided light box

## Single digital screen kit



- supplied with 6mm rod and transformer

Item Code:

KDA3R-DC

Ask about the new range of 19" and 32" Digital Screens

## Multiple and combination kits



### 3 cold cathode light boxes

- supplied with 6mm rods and transformer

Code: Description:

KD2R-DC 3 x single sided light boxes

KD2R-D-DC 3 x double sided light boxes



### 1 digital screen, 1 cold cathode light box & 1 double A4 acrylic pocket

- supplied with 6mm rods and transformer

Code: Description:

KD3-DC Includes 1 single sided light box, 1 digital screen & 1 double A4 pocket

KD3-D-DC Includes 1 double sided light box, 1 digital screen & 1 double A4 pocket



### 1 digital screen plus 2 cold cathode light boxes

- supplied with 6mm rods and transformer

Code: Description:

KD4-DC Includes 2 single sided light boxes & 1 digital screen

KD4-D-DC Includes 2 double sided light boxes & 1 digital screen



### 1 digital screen on freestanding InfoPost

- 1500mm high InfoPost with circular base
- supplied with electronic transformer and 2m cable and 3 pin plug

Code: Description:

IPD Digital screen on infopost

# Digital displays - 27"

## 27" Digital Screen and matching light box kit



- supplied with 3m drop of rod, transformer, power connectors, isolators and operating manual.

Item Code:	Size:
KDA2R-DC	1 x 27" Digital Screen on rods
KD6-DC	1 x Single Sided Light Box on rods
KD7-DC	1 x Digital Screen and 1 x Single Sided Light Box on rods
KD8-DC	3 x Single Sided Light Boxes on rods
KD9-DC	1 x Digital Screen, 2 x Single Sided light Boxes on rods

Upload files onto CF card using either a reader/writer or a USB Stick. Alternatively use as a display monitor linking back to a computer via a VGA port.

The unit will display jpegs or mpeg 1 or 2 from the compact flash card. When used as a monitor connected via the VGA port it will display your computer screen.



Technical Specification	Digital Screen		Light Boxes	
	DA3-17W-DC	LB127W	DCA3-DC	DCA2-DC
Digital Screen Size	17"	27"		
Viewing Ratio	16.9	16.9		
Pixel Pitch	0.289 x 0.289	0.145 x 0.436		
Max. Resolution	1280 x 768	1366 x 768		
Colour	16.2M	16.7M		
Contrast	800:1	1200:1		
Response Time (Tr/Ff) (ms)	15/20	6/5		
Viewing Angle	170°/170°	176° /176°		
Video System	NTSC/PAL	NTSC/PAL		
Backlight	4CCFL	4CCFL		
Speaker	2W x 2	5W x 2		
Input - for fast file up/download from PC	USB2.0	USB2.0, VGA analogue 15 pin		
Audio Output	Yes	Yes		
Storage Device	CF type 1/11	CF type 1/11		
OSD	Yes	Yes		
Function Keys	Yes	Yes		
CF Security	Yes	Yes		
Video In/Out	Yes	Yes		
Vesa Mount	100mm	100/200mm		
Changeable Graphics			Removable Magnetic Panel	
Graphic Formats			Backlits, transparencies, 90gsm paper	
Poster Size			420 x 297	670 x 420
Viewing Area			418 x 296	645 x 392
Backlight Lamp Rating	50,000 hrs			
Brightness	450cd sq	500 cd sq	2000 lux	2400 lux
Power consumption	60 Watt	120 Watt	20 Watt	30 Watt
Power Supply	12V-DC	24V-DC	12V-DC	24V-DC
Operating Temperature	0° - 60°C			
Humidity	5% - 95%			
Dimensions (W x H x D)	520x400x56	774x520x75	520x400x25	774x520x35
Net Weight (kg)	4.7	9.0	1.6 Single 2.0 Double	4.5

# Digital displays

Totally unique digital screens and cold cathode light boxes powered via the low-voltage rod system



## Digital Screens 17" and 27"

- ultra slim 53mm depth screen which simply clips onto the rod system
- 17" and 27" wide LCD Screen
- Add rods or VESA mount (standard or sideways)
- all the unit needs to run is a memory card with data downloaded directly from a digital camera or PC
- you can install jpeg images, mpeg video and sound files
- to load the digital screen you will need a USB card reader and a compact flash memory card.

Item Code:	Size:
DA3-17W-DC	<b>A3 17" LCD Digital Screen</b> (60 watts/12 volt) supplied with PO2-M4 supports and a compact demo card See website for current prices
D27W-DC	<b>27" LCD Digital Screen</b> supplied with PO2-M4 supports and a compact flash card

## Cold cathode light boxes - suspended

Use on their own as an illuminated header with acrylic pockets underneath, a bank of three units one under the other, or as part of a display with the digital screen.

- Completely even spread of light which eliminates shadows
- Invisible power supply, no ugly power cables
- Use standard paper posters up to 90 gsm or inkjet prints
- Units are very light weight
- Incredibly bright approx 2,000 lux levels
- Single or double sided options
- 17" poster size - 420mm x 297mm, viewing area 418mm x 296mm
- 27" poster size - 670mm x 420mm, viewing area 645mm x 390mm

Item Code:	Size:
DCA3-DC	<b>A3 single sided, landscape/portrait</b> (20 watts/12 volt) supplied with PO2-M4 supports
DCDA3-DC	<b>A3 double sided, landscape/portrait</b> (20 watts/12 volt) supplied with PO2-M4 supports
DCA2-DC	<b>670 x 420 single sided</b> (30 watts/24 DC)

## Transformers

- single-circuit transformers, supplied with 2m input lead and 1m output lead.
- provides protection against overheating, overloading and short-circuits

Item Code:	Spec	Size: W x D x H in mm
LT13.8-25	<b>200 VA</b> rods only	270 x 160 x 120
LT192-24DC	<b>192 VA</b> rods only	200 x 60 x 120
PSU-192-24DC	<b>192 VA</b> standalone	200 x 60 x 120
PSU-UK3	<b>60 VA</b> standalone	110 x 64 x 32

### Important fitting information:

- Digital screens should only be installed onto 6mm rod systems
- Cold cathode light boxes can be installed onto 6mm rods maximum 200 watts
- **All power supply is DC**
- 17" Screen rated at 60 watts /12 volt
- 27" Screen rated at 120 watts /24 volts
- A3 Light box rated at 20 watts /12 volt
- 670 x 420 Light box rated at 30 watts /24 volt

Mix and match the units by adding the accumulated watts and providing the figure is under the maximum system wattage then you can install the units.

### Ordering checklist:

1. Rods for lightboxes and digital screens
2. VESA mounts for digital screens when mounting directly to the wall or suspending from ceiling poles
3. Select suitable transformer from list above
4. Power connectors (p59)
5. Four supports per unit (p33 - rods)
6. Isolators (p59)
7. Spare compact flash card or USB stick (from local supplier)
8. Software - discuss with client what software they will use to update system. Recommend DVD pix player for the non-professional - full details on request
9. Guarantee level required - e.g. return to base or full service level. Needs to be agreed at point of order

# Promotional material

## Samples

Increase your sales by using samples which enable you to show the quality and design of the product. Remember - once your client sees and touches the product they normally purchase, as they are so delighted with the quality and design. The samples have been vastly reduced in price and are NOT subject to any discounts.

### Sample snake

- 1.5mm cable supplied with top/bottom fittings.
- length 1 metre
- fittings: CG01, CG02, CG03/PC, CG04, CG06, CG09, CG11, CS01/BR, CS13

Item Code:

**CSC**

### Sample frame

- complete frame ideal for dropping in your briefcase
- extensive range of cable and rod samples with a 1/3 A4 acrylic pocket
- size 430mm wide x 310mm high

Item Code:

**CSF**

### Sample 3mm rod

- 3mm rod (100mm length) supplied with REC end cap and a CG03 support

Item Code:

**RB1-S**

### Freestyle sample frame

- supplied with quick fit cables and a business card holder supported with CG03 supports

Item Code:

**SFS**

### Sample cases

Order a case and we will give you a credit on your account against your next order - £50 credit for the large case and £25 credit for small case (valid on orders over £200).

#### Small

- small lightweight blue plastic case with cables/rods and wall mounted supports
- 350mm w x 300mm h x 65mm d

#### Large:

- Large heavy duty black plastic case with a comprehensive range of cable/rod fittings, plus low voltage lighting sample
- 390mm w x 290mm h x 135mm d

Item Code: Size:

**SC/S**    **Small**  
**SC/L**    **Large**

## Brochures



Order additional full colour brochures to help with your marketing - available in non-branded formats, blank for you to add your address details

- see back cover for brochure contents

- first 10 FREE!

Item Code:	Brochure:	No. of pages	No in pack:
<b>FSB6/BLK</b>	Freestyle brochure	<b>6</b>	<b>100</b>
<b>EMB6/BLK</b>	E-motion brochure	<b>6</b>	<b>100</b>
<b>WDB/BLK</b>	37 ways...	<b>32</b>	<b>100</b>
<b>CB/BLK</b>	Display Collection	<b>74</b>	<b>10</b>
<b>HTB/BLK</b>	Hightrack brochure	<b>6</b>	<b>100</b>
<b>SB/BLK</b>	Sign brochure	<b>6</b>	<b>100</b>
<b>PD/BLK</b>	Poster Displays	<b>4</b>	<b>100</b>
<b>DB/BLK</b>	Digital Brochure	<b>12</b>	<b>10</b>

# Component measurements

All measurements are in millimetres unless stated L=Length W=Width H=Height Ø=Diameter D=Depth Int=Internal  
**Guarantee** All metal components have a lifetime guarantee. All other products excluding lamps and fuses are covered under a 12 month warranty.

Item code:	Allen key:	Page No.	Dimensions:
AC		26	W=19; H=11.5
ACD		26	W=28; H=9.5
ACL		26	W=28; H=9.5
C2		18	2m cable; top fitting Ø=16
C2A4F	● ●	19	Top fitting Ø=18; floor fitting Ø=15
C2CW-15	● ●	19	Wall brackets Ø=38; 40mm from wall to back cable; floor fitting Ø=16
C2CW-30	● ●	19	Wall brackets Ø=38; 40mm from wall to back cable; floor fitting Ø=16
C2WF-15	● ●	19	Wall brackets Ø=38; 40mm from wall to back cable; floor fitting Ø=15
C2WF-30	● ●	19	Wall brackets Ø=38; 40mm from wall to back cable; floor fitting Ø=15
C2WW-15	● ●	19	Wall brackets Ø=38; 40mm from wall to back cable
C2WW-30	● ●	19	Wall brackets Ø=38; 40mm from wall to back cable
CA4	●	17	4m cable; top fitting Ø=16; bottom fitting Ø=15
CA4-3	●	24	Top fitting Ø=16; bottom fitting Ø=15
CAA	● ●	17	4m cable; fittings Ø=38
CAF	● ●	17	4m cable; top bracket Ø=38; floor fitting Ø=15
CAT	●	18	Weight 100H x 30Ø; weighs 0.55kg
CCT	●	18	Weight 100H x 30Ø; weighs 0.55kg
CCW	●	17	3m cable; top fitting Ø=16; projects 40 from wall
CD-4	●	18, 24	W=5; Ø=25
CD-10	●	37	W=5; Ø=25
CG01	●	20	L=20; Ø=16
CG01-3	● ●	24, 31	L=21; Ø=16
CG02	●	20	L=32; Ø=16
CG03	●	20	L=15; Ø=10
CG03-3	●	31	L=15; Ø=10
CG04	●	20	L=22; Ø=10
CG04-3	●	31	L=22; Ø=10
CG06	●	22	L=20; Ø=16
CG07	●	22	L=32; Ø=16
CG08	●	20	L=31; Ø=21; 8.5mm Ø hole required 15mm from edge of panel
CG09	●	20	L=22; Ø=16
CG11	● ●	20, 22	L=27; Ø=16
CG11-3	● ● ●	25, 31	L=28; Ø=16
CG12	● ●	20	L=30; Ø=18
CG12-3	● ● ●	24, 31	L=31; Ø=18
CG13	● ●	20, 22	L=27; Ø=18
CG13-3	● ● ●	25, 31	L=28; Ø=18
CG14	● ●	20	L=20; Ø=20.5
CG14-3	● ● ●	24, 31	L=21; Ø=20.5
CG15	● ●	22	L=20; Ø=20.5
CG15-3	● ● ●	25, 32	L=20.5; Ø=21
CG21	● ● ●	20, 22	L=46; Ø=16
CG21-3	● ● ● ●	25, 31	L=46; Ø=16
CG22	● ● ●	20	L=52; Ø=18
CG22-3	● ● ● ●	24, 31	L=52; Ø=18
CG23	● ● ●	20, 22	L=46; Ø=18
CG23-3	● ● ● ●	25, 31	L=46; Ø=18
CH01	● ●	21	L=16; Ø=16
CH01-3	● ● ●	25, 32	L=17; Ø=16
CH02	● ●	21	L=24; Ø=16
CH02-3	● ● ●	25, 32	L=24; Ø=16
CQQ	●	18, 26, 62	2m Cable; top and bottom fitting Ø=16
CS01	●	22	D=11; Ø=16
CS01-3	●	25, 32	D=11; Ø=16
CS03	● ●	21, 47	L=14; Int Ø=12; Int D=6; Ø=16
CS03-3	● ● ●	25, 32, 47	L=15; Int Ø=12; Int D=6; Ø=16
CS04	● ●	21, 47	L=20; Int Ø=12; Int D=6; Ø=16
CS05	● ●	23	L=14; Ø=16
CS05-3	● ● ●	32	L=15; Ø=16
CS06	● ●	23	L=20; Ø=16
CS07	● ●	23	L=28; Ø=16
CS08	● ●	59	L=12; Ø=12
CS08-3	● ● ●	59	L=16; Ø=16
CS09	● ●	23	L=17; Ø=16
CS11	● ● ●	22	L=36; Ø=18
CS11-3	● ● ● ●	25, 32	L=37; Ø=18
CS12	● ●	21	H=28; D=14.6; Ø=16

Item code:	Allen key:	Page No.	Dimensions:
CS12-3	● ●	32	H=27; D=26; Ø=16
CS13	● ●	21	L=21.5; Ø=16
CS13-3	● ● ●	24, 31	L=23.5; Ø=16
CS21	● ●	22	L=64; Ø=16
CS21-3	● ● ●	25, 32	L=64; Ø=16
CS22	● ●	21	H=28; D=21.2; Ø=16
CS23	● ●	21	L=35; Ø=16
CS23-3	● ● ●	24, 31	L=37; Ø=16
CWF	●	17	3m cable; projects 40 from wall; floor fitting Ø=15
CWW	●	17	3m cable; projects 40 from wall; fitting plate Ø=38
HDS		18, 37	D=15; Ø=50
HR10-3	●	31	L=790; Ø=10
KC2-CG05	● ●	18	Top fitting Ø=16; support Ø=23
KC2-CG05-10	● ● ●	18	Top fitting Ø=16;
KMDB/SI	●	26	H=350; D=350; cables/rods project 40mm & 340mm from wall
KMSB-25/SI		26	H=30; Ø=35; cable fitting 25mm from wall
KMSB/SI		26	H=60; Ø=60; cable fitting 50mm from wall
KMSB-100/SI		26	H=110; Ø=110; cable fitting 100mm from wall
P01		15	Ø=38
P01-PC01		18, 24, 37	H=15; Ø=38
P02		21, 25, 32, 33, 35, 39	Ø=12; D=6
P08	●	15, 22, 25, 32, 36, 39	H=8; Ø=16
PC01/I		26, 59	L=12; Ø=16
PC31		14	L=18
PR01-I		26, 59	L=12; Ø=16
R1000-10		37	L=1000; Ø=10
R1000P		23, 33	L=1000; Ø=6
R1500		33	L=1500; Ø=6
R1500-10		37	L=1500; Ø=10
R500		33	L=500; Ø=6
R500-10		37	L=500; Ø=10
R500P		23, 33	L=500; Ø=6
RAAS	● ●	33	Top fitting Ø=15; bottom fitting Ø=18
RAS	●	33	Top & bottom fitting Ø=18
RAS-10		37	Top fitting Ø=20; Bottom fitting Ø=22
RB1		30	1m rod; top fitting Ø=16
RB2		30	2m rod; top fitting Ø=16
RB3		30	3m rod; top fitting Ø=16
RBCF3		30	3m rod; top fitting Ø=16; bottom fitting Ø=15
RBT1		30	1m rod; top fitting Ø=16
RBT2		30	2m rod; top fitting Ø=16
RBT3		30	3m rod; top fitting Ø=16
RBTf3		30	3m rod; top fitting Ø=16; bottom fitting Ø=15
RC10-6	●	37	L=25; Ø=10
REC	●	23, 33	L=16; Ø=12
REC-10		31, 37	L=15; Ø=10
REC-P/BL		23, 33	L=17; Ø=8.5
RG01	●	34	L=25; Ø=16
RG01-10	● ●	38	L=29; Ø=18
RG02	● ●	34	L=36; Ø=16
RG02-10	● ● ●	38	L=40; Ø=18
RG05	● ●	35	L=16; Ø=16
RG06	● ●	36	L=25; Ø=16
RG06-10	● ● ●	39	L=29; Ø=18
RG07	● ●	36	L=36; Ø=16
RG07-10	● ● ●	39	L=40; Ø=18
RG11	● ● ●	34, 36	L=30; Ø=16
RG11-10	● ● ● ●	38	L=34; Ø=18
RG12	● ● ●	34	L=33; Ø=18
RG12-10	● ● ● ●	38	L=37; Ø=18
RG13	● ● ●	34, 36	L=30; Ø=18
RG13-10	● ● ● ●	38	L=34; Ø=18
RG14-10	● ● ●	38	L=29; Ø=20.5
RG21	● ● ●	34, 36	L=46; Ø=16
RG21-10	● ● ● ●	38	L=68; Ø=16
RG22	● ● ●	34	L=52; Ø=18
RG22-10	● ● ● ●	38	L=56; Ø=18

Item code:	Allen key:	Page No.	Dimensions:
RG23	● ●	34, 36	L=46; Ø=18
RG23-10	● ● ●	38	L=50; Ø=18
RGN01	● ●	34	L=25; Ø=16
RH01	● ●	35	L=19; Ø=16
RH01-10	● ●	38	L=23; Ø=18
RH02	● ●	35	L=24; Ø=16
RH02-10	● ●	38	L=28; Ø=18
RP	● ●	33	Ø=18
RPA	● ●	33	Ø=15
RR01	● ● ●	36	L=31; Ø=16
RR01-10	● ● ● ●	39	L=40; Ø=18
RR01-3/10	● ● ● ●	32	L=33; Ø=18
RR01-3/6	● ● ● ●	32	L=29; Ø=16
RR01-6/10	● ● ● ●	39	L=56; Ø=18
RS		33	Ø=18
RS01	● ●	35	D=11; Ø=16
RS03	● ●	33, 35, 47	L=17.5; Int Ø=12; Int D=6; Ø=16
RS03-10	● ● ●	39, 47	L=22; Ø=18
RS04	● ●	35, 47	L=21; Int Ø=12; Int D=6; Ø=16
RS04-10	● ● ●	39, 47	L=26; Ø=18
RS05	● ● ●	36	L=17; Ø=16
RS05-10	● ● ● ●	39	L=22; Ø=18
RS06	● ● ●	36	L=20; Ø=16
RS06-10	● ● ● ●	39	L=26; Ø=18
RS08	● ● ●	59	L=18; Ø=16
RS-10		37	L=22; Ø=20
RS11	● ● ●	36	L=39; Ø=16
RS11-10	● ● ● ●	39	L=43; Ø=18
RS12	● ●	35	H=28; D=18.1; Ø=16
RS12-10	● ● ●	38	L=20; Ø=18
RS13	● ● ●	34	L=25; Ø=16
RS13-10	● ● ● ●	38	L=30; Ø=18
RS21	● ● ●	36	L=64; Ø=16
RS21-10	● ● ● ●	39	L=68; Ø=18
RS22	● ● ●	35	L=30; D=24.2; Ø=16
RS23	● ● ●	34	L=38; Ø=16
RS23-10	● ● ● ●	38	L=38; Ø=18
RSA	● ●	33	Ø=15
WM01	● ● ●	15	L=30
WM02	● ● ●	15	L=30
WM03	● ● ●	15	L=16
WM04	● ● ●	15	L=16
WM05	● ● ●	13	L=14; Ø=16
WM05-13	● ● ● ●	13	L=25; Ø=16
WM05L-20	● ● ● ●	13	L=40; Ø=16
WM06	● ● ●	15	L=19; Ø=16
WM07	● ● ●	15	L=28; Ø=16
WM08	● ● ●	13	L=32; Ø=16
WM09	● ● ●	14	L=31; Ø=16
WM10	● ● ●	15	L=39; Ø=16; 24mm from wall
WM11	● ● ●	33	L=31; Ø=16
WM11-10	● ● ● ●	37	L=36; Ø=18
WM11L-10	● ● ● ●	37	L=59; Ø=18
WM12	● ● ●	13	L=20; Ø=12
WM15	● ● ●	13	L=25; Ø=25
WM16	● ● ●	13	L=50; Ø=25
WM17	● ● ●	13	L=75; Ø=25
WM18	● ● ●	13	L=25; Ø=16
WM19	● ● ●	13	Ø=16
WM20	● ● ●	14	Ø=25; D=5.5
WMS-2		14	D=2
WMS-3		14	D=3

ALLEN KEYS:  
 To see which allen key each component requires, check the colour code in the list above against the grid below:

AK1.5	1.5mm	●
AK2.0	2.0mm	●
AK2.5	2.5mm	●
AK3.0	3.0mm	●
AK4.0	4.0mm	●
AK5.0	5.0mm	●
AK6.0	6.0mm	●

## Other brochures available:



**Signedge:** the NEW, most versatile sign system of its kind.



**Estate Agents Brochure:** Inspirational ideas for all types of Estate Agency displays.



**Cold Cathode light boxes:** Economical and long life light boxes.



**Digital Signage:** Increase the impact of any display by adding sound and moving images.



**Poster Displays:** Range of easy to order kits - available in a PDF format with and without prices.

**Freestyle:** Creative ideas for using freestanding units in retail outlets, concessions, banks, estate agents, museums, airports, reception areas, showrooms, leisure centres, information centres and exhibition stands.

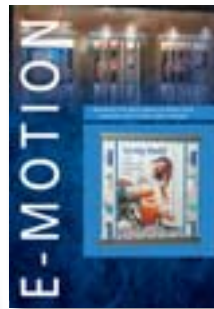

**E-motion:** Stop people in their tracks with the highly attractive e-motion rotating display units.



**Tips Booklet:** A real must for anyone who is responsible for designing and specifying window displays. Thirty two pages packed with useful tips to help maximise sales.

**Balance:** New, elegant freestanding poster, digital screen and leaflet dispenser range.



Brochures are usually available as print or in pdf format - email us today to order.



**Sign Supports:** Concept ideas for creating powerful signage.

## Displays, signage and lighting that increase sales